



FLECK® 5600
SERVICE MANUAL



TABLE OF CONTENTS

JOB SPECIFICATION SHEET	3
INSTALLATION.....	3
START-UP INSTRUCTIONS.....	4
SYSTEM DISINFECTION.....	4
MODEL 5600 WITH TIME CLOCK INSTALLATION AND START-UP PROCEDURES	5
MODEL 5600 BACKWASH FILTER INSTALLATION AND START-UP PROCEDURES	6
MODEL 5600 METERED INSTALLATION AND START-UP PROCEDURES	7
WATER CONDITIONER FLOW DIAGRAMS	8
MODEL 5600 CONTROL VALVE DRIVE ASSEMBLY	10
5600 ELECTROMECHANICAL	16
5600 VALVE ACCESSORIES	17
5600 VALVE ASSEMBLIES	18
SERVICE INSTRUCTIONS	21
TROUBLESHOOTING	24
GENERAL SERVICE HINTS FOR METER CONTROL	25
MODEL 5600SF TROUBLESHOOTING	25

IMPORTANT PLEASE READ:

- THE INFORMATION, SPECIFICATIONS AND ILLUSTRATIONS IN THIS MANUAL ARE BASED ON THE LATEST INFORMATION AVAILABLE AT THE TIME OF RELEASE. THE MANUFACTURER RESERVES THE RIGHT TO MAKE CHANGES AT ANY TIME WITHOUT NOTICE.
- THIS MANUAL IS INTENDED AS A GUIDE FOR SERVICE OF THE VALVE ONLY. SYSTEM INSTALLATION REQUIRES INFORMATION FROM A NUMBER OF SUPPLIERS NOT KNOWN AT THE TIME OF MANUFACTURE. THIS PRODUCT SHOULD BE INSTALLED BY A PLUMBING PROFESSIONAL.
- THIS UNIT IS DESIGNED TO BE INSTALLED ON A POTABLE WATER SYSTEM ONLY AND IS NOT INTENDED TO TREAT WATER THAT IS MICROBIOLOGICALLY UNSAFE OR OF UNKNOWN QUALITY WITHOUT ADEQUATE DISINFECTION BEFORE AND AFTER THE SYSTEM.
- THIS PRODUCT MUST BE INSTALLED IN COMPLIANCE WITH ALL STATE AND MUNICIPAL PLUMBING AND ELECTRICAL CODES. PERMITS MAY BE REQUIRED AT THE TIME OF INSTALLATION.
- IT IS ESTABLISHED THAT WHEN DAYTIME WATER PRESSURE EXCEEDS 80 PSI (5.5 BAR), THE MAXIMUM PRESSURE RATING OF 125 PSI (8.6 BAR) CAN BE EXCEEDED. A PRESSURE REGULATOR MUST BE INSTALLED ON THIS SYSTEM OR WARRANTY IS VOIDED.
- DO NOT INSTALL THE UNIT WHERE TEMPERATURES MAY DROP BELOW 32°F (0°C) OR ABOVE 120°F (52°C).
- DO NOT PLACE THE UNIT IN DIRECT SUNLIGHT. BLACK UNITS WILL ABSORB RADIANT HEAT INCREASING INTERNAL TEMPERATURES.
- DO NOT STRIKE THE VALVE OR ANY OF THE COMPONENTS.
- WARRANTY OF THIS PRODUCT EXTENDS TO MANUFACTURING DEFECTS. MISAPPLICATION OF THIS PRODUCT MAY RESULT IN FAILURE TO PROPERLY CONDITION WATER, DAMAGE TO PRODUCT, OR PERSONAL INJURY.
- A PREFILTER SHOULD BE USED ON INSTALLATIONS IN WHICH FREE SOLIDS ARE PRESENT.
- IN SOME APPLICATIONS LOCAL MUNICIPALITIES TREAT WATER WITH CHLORAMINES. HIGH CHLORAMINE LEVELS MAY DAMAGE VALVE COMPONENTS.
- CORRECT AND CONSTANT VOLTAGE MUST BE SUPPLIED TO THE CONTROLLER TO MAINTAIN PROPER FUNCTION.
- THE SYSTEM IS INTENDED TO TREAT ONLY POTABLE QUALITY WATER. IT IS NOT INTENDED AS THE PERMANENT PRIMARY TREATMENT OF WATER FROM A SOURCE THAT IS CONTAMINATED, SUCH AS FROM RADON, PESTICIDES, INSECTICIDES, SEWAGE OR WASTEWATER.
- THIS SYSTEM IS NOT INTENDED FOR USE BY PERSONS (INCLUDING CHILDREN) WITH REDUCED PHYSICAL, SENSORY, OR MENTAL CAPABILITIES, OR LACK OF EXPERIENCE AND KNOWLEDGE, UNLESS THEY HAVE BEEN GIVEN SUPERVISION OR INSTRUCTION CONCERNING USE OF THE APPLIANCE BY A PERSON RESPONSIBLE FOR THEIR SAFETY.
- CHILDREN SHALL NOT PLAY WITH THE SYSTEM.
- CLEANING SHALL NOT BE MADE BY CHILDREN WITHOUT SUPERVISION.
- PERIODIC CLEANING AND MAINTENANCE MAY BE REQUIRED TO FUNCTION PROPERLY. SEE DISINFECTION INSTRUCTIONS ON PAGE 4.

CALIFORNIA PROPOSITION 65 WARNING

▲ WARNING: This product contains chemicals known to the State of California to cause cancer or birth defects or other reproductive harm.

JOB SPECIFICATION SHEET

Job Number: _____

Model Number: _____

Water Hardness: _____

ppm or gpg

Capacity Per Unit: _____

Mineral Tank Size: _____ Diameter: _____

Height: _____

Salt Setting per Regeneration: _____

1. Type of Timer:

- A. Time Clock
- B. Meter Initiated

2. Downflow: Upflow Upflow Variable

3. Meter Size:

- A. 3/4-inch Turbine
- B. 3/4-inch Paddle Wheel
- C. Electronic _____ Pulse Count _____ Meter Size _____

4. System Type:

- A. System #4: 1 Tank, 1 Meter, Immediate, or Delayed Regeneration
- B. System #4: Time Clock

5. Valve Operating Parameters:

5600

Minimum operating pressure:	20 psi / 1.4 bar / 138 kPa
Maximum operating pressure:	125 psi / 8.61 bar / 861 kPa
Minimum water temperature:	34° F / 1° C
Maximum water temperature:	110° F / 43° C
Maximum Ambient temperature:	120° F / 52° C
Maximum humidity:	75%
Input Voltage:	120 Volts AC / 60 Hz
Maximum Watts:	3 watts
Maximum altitude:	2000 meters

6. Timer Program Settings:

- A. Backwash: _____ Minutes
- B. Brine and Slow Rinse: _____ Minutes
- C. Rapid Rinse: _____ Minutes
- D. Brine Tank Refill: _____ Minutes
- E. Pause Time: _____ Minutes
- F. Second Backwash: _____ Minutes

7. Drain Line Flow Control: gpm

8. Brine Line Flow Controller: gpm

9. Injector Size#:

INSTALLATION

Water Pressure

A minimum of 25 psi (1.7 bar) of water pressure is required for regeneration valve to operate effectively.

Electrical Warnings & Caution Statement

An uninterrupted alternating current (A/C) supply is required.

NOTE: Other voltages are available. Please make sure your voltage supply is compatible with your unit before installation.

Grounding Instructions

This appliance must be grounded. In the event of a malfunction or breakdown, grounding will reduce the risk of electric shock

by providing a path of least resistance for electric current. This appliance is equipped with a cord having an appliance-grounding conductor and a grounding plug. The plug must be plugged into an appropriate outlet that is installed and grounded in accordance with all local codes and ordinances.

⚠ WARNING: Improper connection of the appliance-grounding conductor can result in a risk of electric shock. Check with a qualified electrician or service representative if you are in doubt whether the appliance is properly grounded. Do not modify the plug provided with the appliance; if it will not fit the outlet, have a proper outlet installed by a qualified technician.

⚠ WARNING: Risk of electric shock. Disconnect power before servicing.

FOR DRY LOCATIONS USE ONLY.

The cover should only be removed during installation set-up and maintenance by a qualified service person.

Existing Plumbing

Condition of existing plumbing should be free from lime and iron buildup. Piping that is built up heavily with lime and/or iron should be replaced. If piping is clogged with iron, a separate iron filter unit should be installed ahead of the water softener.

Location of Softener and Drain

The softener should be located close to the drain to prevent air breaks and back flow. You must have an air gap on the drain line to prevent back flow of drain water into the system. The air gap should be two (2) times the diameter of the drain line pipe but must be at least 1-inch.

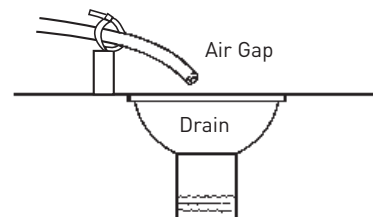

By-Pass Valves

Always provide for the installation of a by-pass valve if unit is not equipped with one.

CAUTION Water pressure is not to exceed 125 psi (8.6 bar), water temperature is not to exceed 110°F (43°C), and the unit cannot be subjected to freezing conditions.

Installation Instructions

1. Place the softener tank where you want to install the unit making sure the unit is level and on a firm base.
2. During cold weather, the installer should warm the valve to room temperature before operating.
3. All plumbing should be done in accordance with local plumbing codes. The pipe size for residential drain line should be a minimum of 1/2 inch (13 mm). Backwash flow rates in excess of 7 gpm (26.5 Lpm) or length in excess of 20 feet (6 m) require 3/4 -inch (19 mm) drain line. Commercial drain lines should be the same size as the drain line flow control.
4. Refer to the dimensional drawing for cutting height of the distributor tube. If there is no dimensional drawing, cut the distributor tube flush with the top of the tank.
5. Lubricate the distributor o-ring seal and tank o-ring seal. Place the main control valve on tank.

INSTALLATION CONTINUED

NOTE: Only use silicone lubricant.

- Solder joints near the drain must be done prior to connecting the Drain Line Flow Control fitting (DLFC). Leave at least 6 inches (15 cm) between the DLFC and solder joints when soldering pipes that are connected on the DLFC. Failure to do this could cause interior damage to the DLFC.
- Plumber tape is the only sealant to be used on the drain fitting. The drain from twin tank units may be run through a common line.
- Make sure that the floor is clean beneath the salt storage tank and that it is level.
- Place approximately 1 inch (25 mm) of water above the grid plate. If a grid is not utilized, fill to the top of the air check (Figure 1) in the salt tank. Do not add salt to the brine tank at this time.
- On units with a by-pass, place in by-pass position. Turn on the main water supply. Open a cold soft water tap nearby and let run a few minutes or until the system is free from foreign material (usually solder) that may have resulted from the installation. Once clean, close the water tap.
- Slowly place the by-pass in service position and let water flow into the mineral tank. When water flow stops, slowly open a cold water tap nearby and let run until the air is purged from the unit.
- Plug unit into an electrical outlet.

NOTE: All electrical connections must be connected according to local codes. Be certain the outlet is uninterrupted.

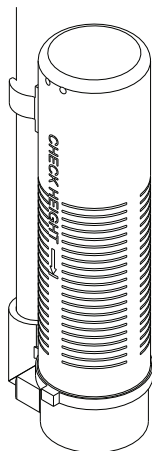

60002 Rev E

Figure 1 Residential Air Check Valve

START-UP INSTRUCTIONS

The water softener should be installed with the inlet, outlet, and drain connections made in accordance with the manufacturer's recommendations, and to meet applicable plumbing codes.

- Turn the manual regeneration knob slowly in a clockwise direction until the program micro switch lifts on top of the first set of pins. Allow the drive motor to move the piston to the first regeneration step and stop. Each time the program switch position changes, the valve will advance to the next regeneration step. Always allow the motor to stop before moving to the next set of pins or spaces.

NOTE: For electronic valves, please refer to the manual regeneration part of the timer operation section. If the valve came with a separate electronic timer service manual, refer to the timer operation section of the electronic timer service manual.

- Position the valve to backwash. Ensure the drain line flow remains steady for 10 minutes or until the water runs clear (see above).
- Position the valve to the brine / slow rinse position. Ensure the unit is drawing water from the brine tank (this step may need to be repeated).
- Position the valve to the rapid rinse position. Check the drain line flow, and run for 5 minutes or until the water runs clear.
- Position the valve to the start of the brine tank fill cycle. Ensure water goes into the brine tank at the desired rate. The brine valve drive cam will hold the valve in this position to fill the brine tank for the first regeneration.
- Replace control box cover.
- Put salt in the brine tank.

NOTE: Do not use granulated or rock salt.

SYSTEM DISINFECTION

Disinfection of Water Softeners

The materials of construction of the modern water softener will not support bacterial growth, nor will these materials contaminate a water supply. During normal use, a softener may become fouled with organic matter, or in some cases with bacteria from the water supply. This may result in an off-taste or odor in the water.

Some softeners may need to be disinfected after installation and some softeners will require periodic disinfection during their normal life.

Depending upon the conditions of use, the style of softener, the type of ion exchanger, and the disinfectant available, a choice can be made among the following methods.

Sodium or Calcium Hypochlorite

Application

These materials are satisfactory for use with polystyrene resins, synthetic gel zeolite, greensand and bentonites.

5.25% Sodium Hypochlorite

These solutions are available under brand names of household bleach. If stronger solutions are used, such as those sold for commercial laundries, adjust the dosage accordingly.

- Dosage
 - Polystyrene resin; 1.2 fluid ounce (35.5 ml) per cubic foot.
 - Non-resinous exchangers; 0.8 fluid ounce (23.7 ml) per cubic foot.

SYSTEM DISINFECTION *CONTINUED*

2. Salt tank softeners
 - A. Backwash the softener and add the required amount of hypochlorite solution to the well of the salt tank. The salt tank should have water in it to permit the solution to be carried into the softener.
 - B. Proceed with the normal recharge.

Calcium Hypochlorite

Calcium hypochlorite, 70% available chlorine, is available in several forms including tablets and granules. These solid materials may be used directly without dissolving before use.

1. Dosage
 - A. Two grains (approximately 0.1 ounce [3 ml]) per cubic foot.
2. Salt tank softeners
 - A. Backwash the softener and add the required amount of hypochlorite to the well of the salt tank. The salt tank should have water in it to permit the chlorine solution to be carried into the softener.
 - B. Proceed with the normal recharge.

MODEL 5600 WITH TIME CLOCK INSTALLATION AND START-UP PROCEDURES

NOTE Install the water softener with the inlet, outlet, and drain connections made according to manufacturer's recommendations and to meet applicable plumbing codes.

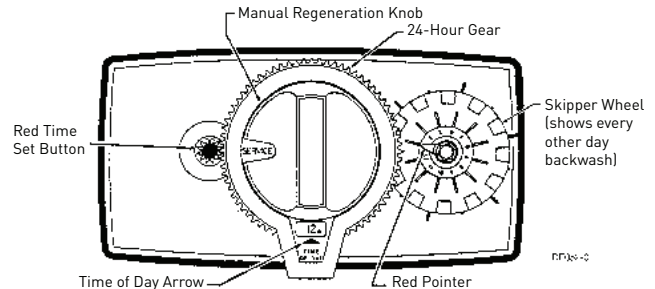

1. Manually index the softener control into the In Service position and let water flow into the resin tank. When the water flow stops, open a softened water tap until all air is released from the lines. Then close tap.

NOTE: Manually dial the various regeneration positions by turning the knob on the front of the control until the indicator shows that the softener is in the desired position.

2. Manually index the control to the Backwash position and allow water to flow at the drain for 3 or 4 minutes.
3. Remove back cover plate.
4. Make sure that the salt dosage is set as recommended by the manufacturer. If necessary, set salt according to the setting instruction sheet. Manually index the control to the Brine Fill position and allow the brine tank to fill to the top of the air check.
5. Manually index the control to the Brine Draw position and allow the control to draw water from the brine tank until it stops.
6. Plug in the electrical cord and look in the sight hole in the back of the motor to see that it is running. Set the days that regeneration is to occur by sliding tabs on skipper wheel outward to expose trip fingers.
 - Each tab is one day.
 - Finger at red pointer is tonight.
 - Moving clockwise from red pointer, extend or retract fingers to obtain the desired generation schedule.
7. Manually advance the control to the beginning of the Brine Fill position and allow the control to return to the In Service position automatically.
8. Fill the brine tank with salt.
9. Replace back cover on the control.
10. Make sure that any bypass valving is left in the normal In Service position.

MODEL 5600 BACKWASH FILTER INSTALLATION AND START-UP PROCEDURES

NOTE: Install the water softener with the inlet, outlet, and drain connections made according to manufacturer's recommendations and to meet applicable plumbing codes.

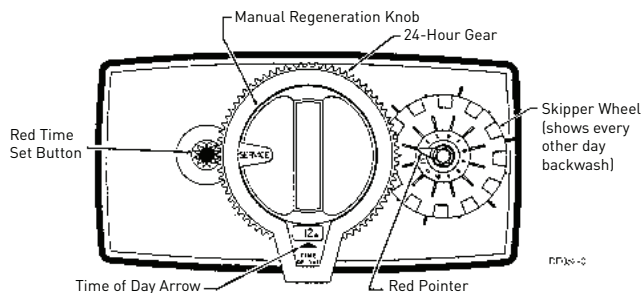

NOTE: Before plugging in the Unit

1. Open a treated water tap down stream of the filter.
2. Manually index the filter to the In Service position and allow the mineral tank to fill by slowly opening the main water supply valve. Any bypass should be in the In Service position.

NOTE: The water flowing from the downstream tap is cloudy and/or contains media fines as well as air. Allow the water to run until it appears clean and free of air.

3. When a steady clean flow appears at the tap, close the tap and the main water supply valve and allow the filter media bed to settle for 15–20 minutes.
4. Manually index the filter to the Backwash position.
5. To prevent a sudden surge of water and air, partially open the main water supply valve so that the flow at the drain of the filter is approximately 1 gpm (3.7 Lpm). The water at the drain is cloudy again and/or contains media fines as well as air. Allow water to flow at the drain until it appears clean and free of air.
6. Continue to open the water supply valve until it is completely open. Allow water to flow at the drain until all media fines are washed out of the filter.
7. Manually index the filter to the In Service position, and again open the downstream tap. Check to be sure that the water flows clear. If necessary, allow water to flow until all media fines are gone. If the tap is equipped with an aerator check that is not plugged with media fines and pipe scale.
8. Plug in the electrical cord and look in the sight hole on the back of the timer motor to ensure that it is running. Set the days backwashing is to occur by sliding tabs on the skipper wheel outward to expose trip fingers. Each tab is one day. Finger at red pointer is tonight. Moving clockwise from red pointer, extend or retract fingers to obtain the desired backwash schedule.
9. Set time of day by pushing red button and spin the 24-hour gear until the present time of day is visible above the time of day arrow.

Cycle Times and Flow Diagrams

1. In Service position. See page 7.
2. Preliminary Rinse position.
 - See page 7 with standard piston (white end plug) or filter piston (black end plug).

- Eliminated with low water piston (gray end plug).
3. Backwash position.
 - See page 7 with standard piston.
 - 15 minutes with filter piston.
 - 7 minutes with low water piston.
 4. Brine Rinse position.
 - Eliminated, resulting in a 50 minute pause, no water flows during this time.
 5. Slow Rinse position.
 - Eliminated, resulting in a 50 minute pause, no water flows during this time.
 6. Second Backwash position.
 - See page 8 with standard piston.
 - 15 minutes with filter piston.
 - 7 minutes with low water piston.
 7. Settling Rinse position.
 - See page 8 with standard or filter piston.
 - Eliminate with low water piston.
 8. Brine Tank Refill position.
 - Eliminated, filter is back in service at this time.

MODEL 5600 METERED INSTALLATION AND START-UP PROCEDURES

NOTE: Install the water softener with the inlet, outlet, and drain connections made according to manufacturer's recommendations and to meet applicable plumbing codes.

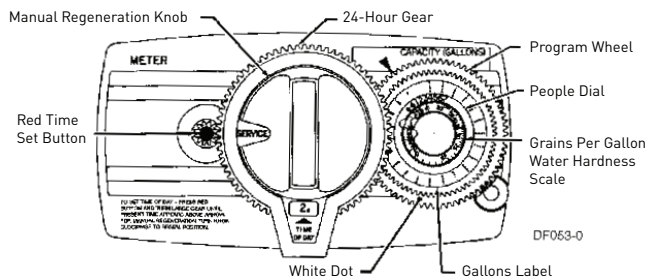

Before plugging in the Unit

1. Manually index the softener control to the In Service position and let water flow into the resin tank. When the water flow stops, open a softened water tap until all air is released from the lines. Then close tap.
2. The various regeneration positions may be dialed manually by turning the knob on the front of the control until the indicator shows that the softener is in the desired position.
3. Set water usage program wheel using any one of the following procedures:

Typical Residential Application

To program, just set the time, set the hardness and it automatically monitors system needs and regenerates only when necessary. To set time of day press red time set button and turn 24-hour gear until present time of day is at "time of day." Set program wheel by lifting the "people" dial and rotating it so that the number of people in the household is aligned with the household grains per gallon water hardness. Release the dial and check for firm engagement at setting. This method provides reserve capacity based on 75 gallons per person.

Optional Programming Procedures

Calculate the gallon capacity of the system, subtract the necessary reserve requirement and set the gallons available at the small white dot on program wheel gear. Note, drawing shows 850 gallon setting. The capacity (gallons) arrow denotes remaining gallons exclusive of fixed reserve.

4. Rotate program wheel counterclockwise until it stops at Regeneration position.
5. Manually index the control to the Backwash position and allow water to flow at the drain for 3 or 4 minutes.
6. Remove back cover plate.
7. Make sure than the salt dosage is set as recommended by the manufacturer. Manually index the control to the Brine Fill position and allow the brine tank to fill to the top of the air check.
8. Manually index the control to the Brine Rinse position and allow the control to draw water from the brine tank until it stops. Plug in the electrical cord and look in the sight hole in the back of the monitor to see that it is running.
9. Manually advance the control to the beginning of the Brine Fill position and allow the control to return to the In Service position automatically.
10. Fill the brine tank with salt.
11. Replace back cover on the control. Be sure cable is not pinched between cover and housing.
12. Make sure that any bypass valving is left in the normal In Service position.
13. Manually index the filter to the In Service position and allow the mineral tank to fill by slowly opening the main water supply valve. Any bypass should be in the In Service position.

WATER CONDITIONER FLOW DIAGRAMS

Service Position

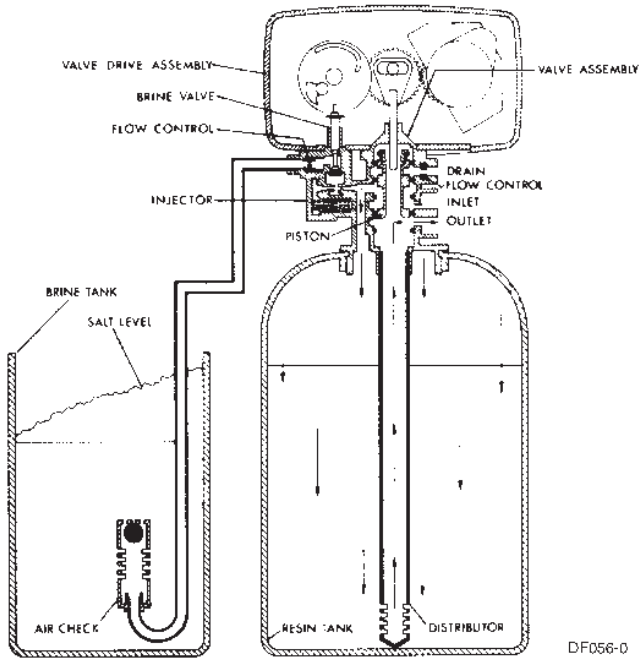

Backwash Position

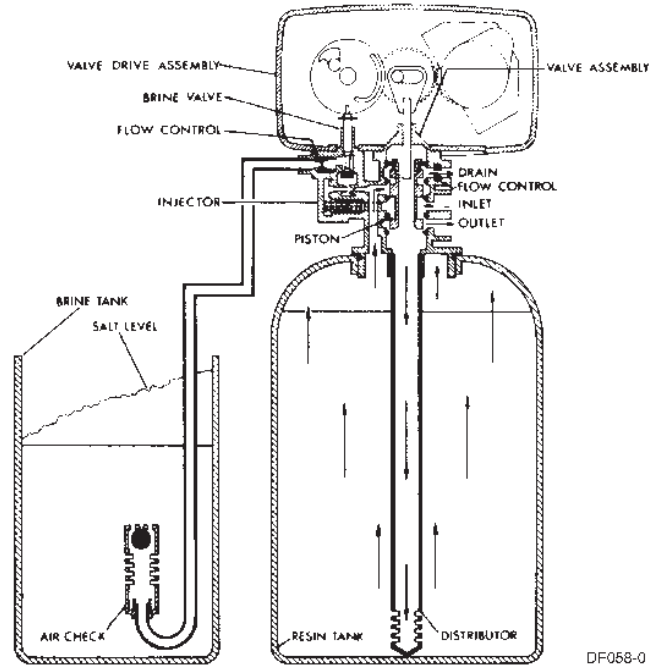

Preliminary Rinse Position

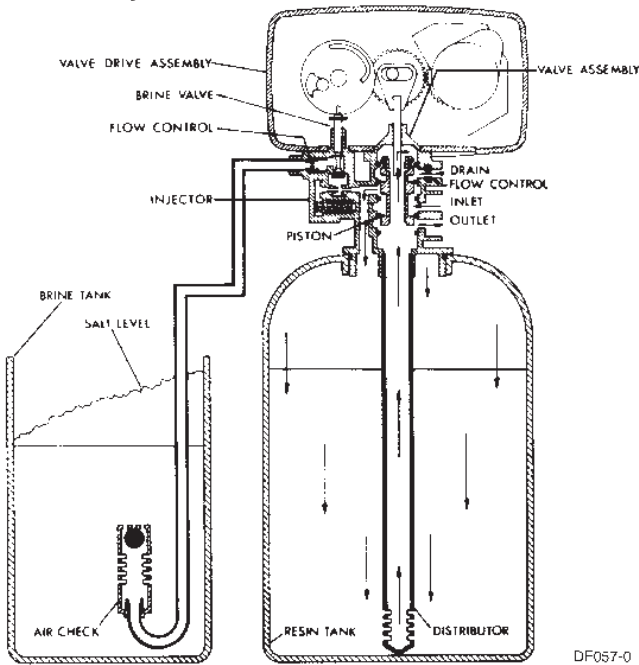

Brine Position

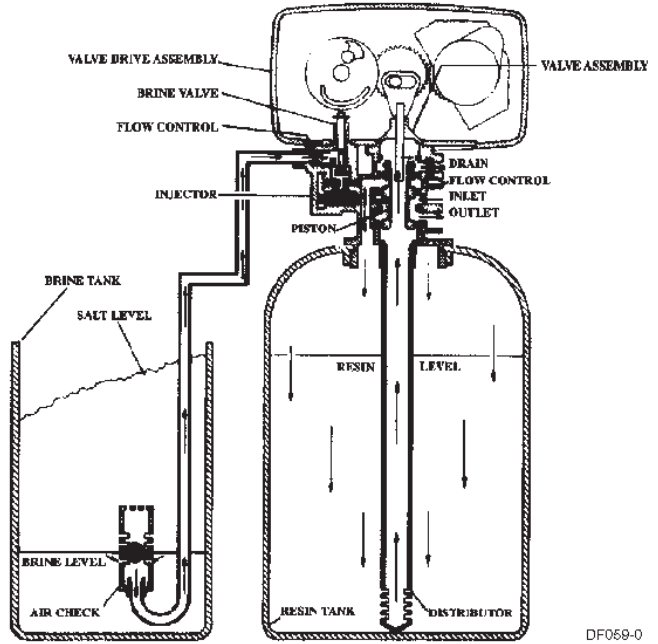

Slow Rinse Position

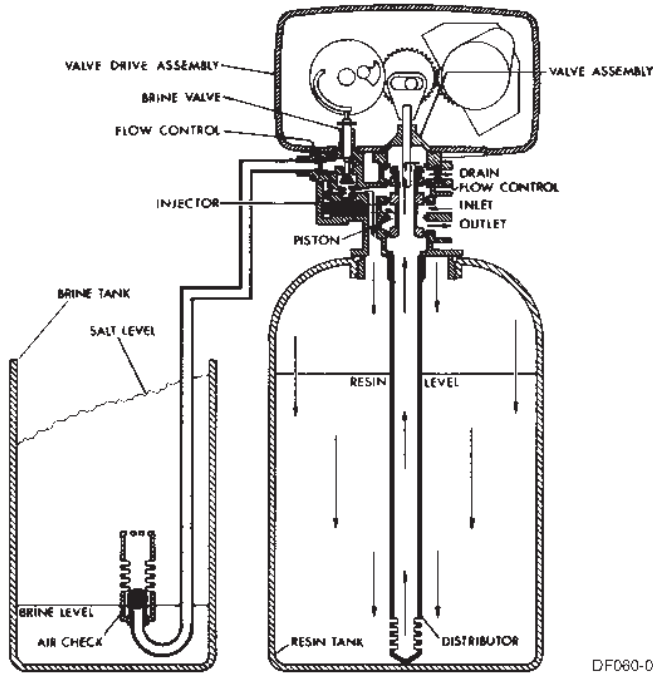

Settling Rinse Position

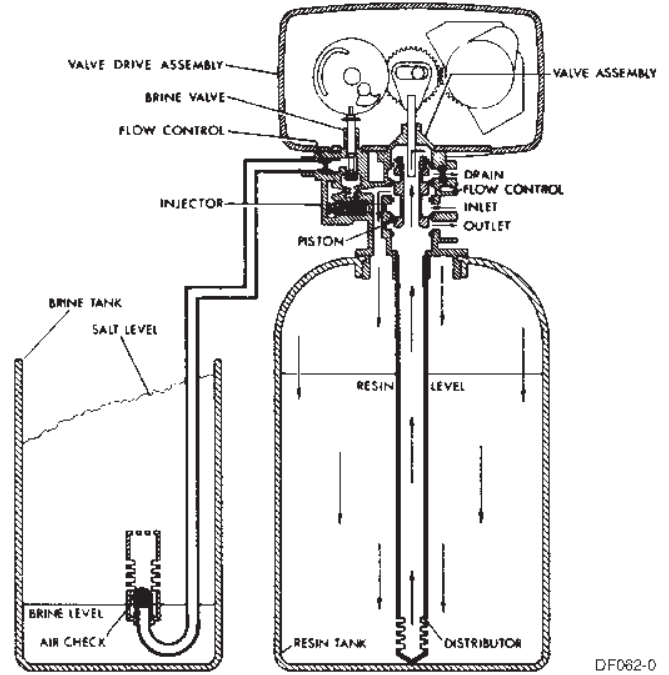

Second Backwash Position

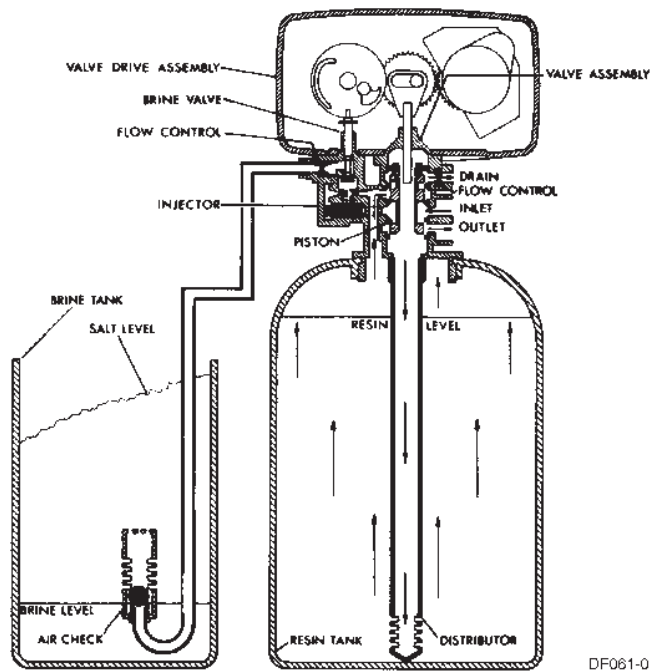

Brine Tank Fill Position

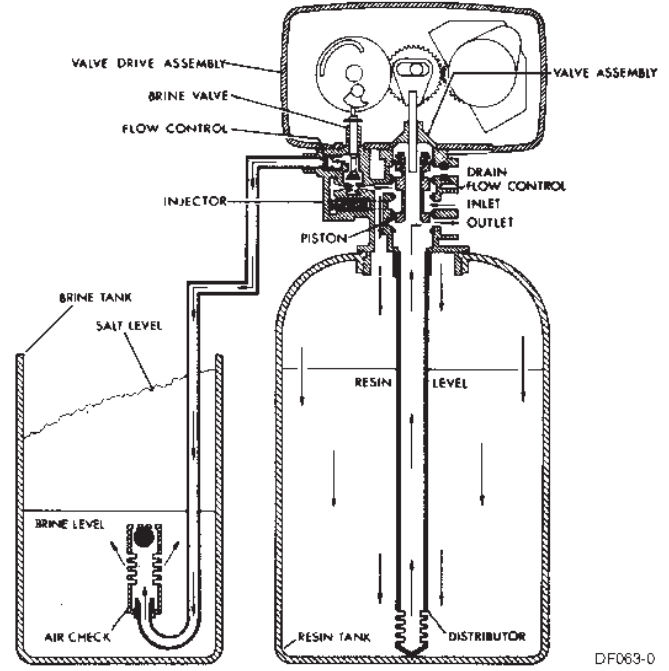

MODEL 5600 CONTROL VALVE DRIVE ASSEMBLY

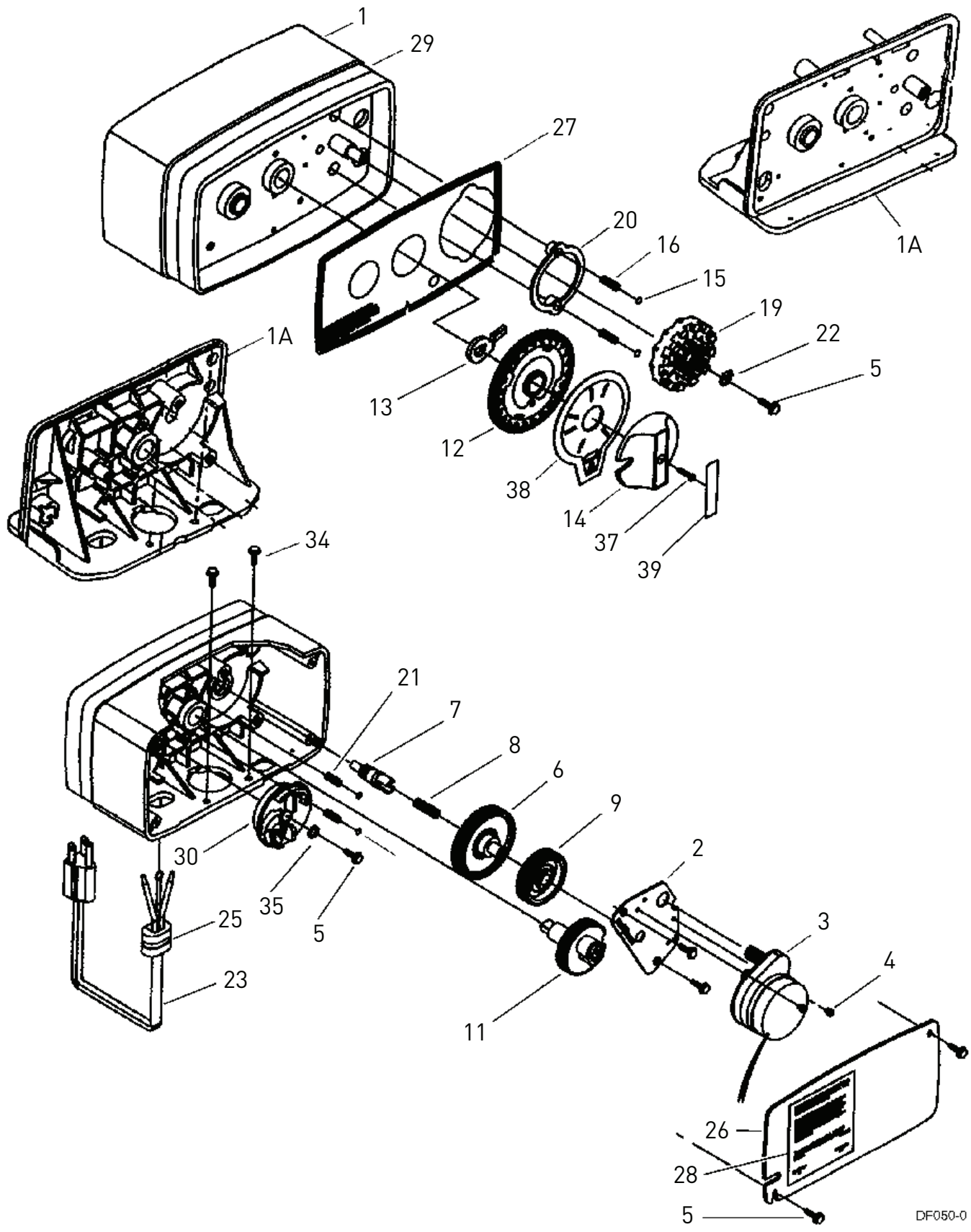

DF050-0

MODEL 5600 CONTROL VALVE DRIVE ASSEMBLY *CONTINUED*

Item No.	QTY	Part No.	Description	Item No.	QTY	Part No.	Description
1	1	14448-001	Drive Housing, with Pin Drilled for Cover				Standard
1A	1	15494-03	"L" Housing, with Pin Drilled for Designer	1	14278		Valve Position Dial, Low Water
2	1	13175	Motor Mounting Plate	1	15478		Valve Position Dial, Chemical Filter
3	1	18743	Motor, 120V, 60 Hz	1	16715		Valve Position Dial, Filter
	1	19659	Motor, 24V, 60 Hz	39	1	14175	Knob Label, Beige
4	(2-3)	11384	Screw, Motor Mtg. and Ground Wire	1	14207		Knob Label, Silver
5	(3-5)	13296	Screw, Component Mounting	40s	1	40214	Screw, Brine Cam
6	1	13017	Idler Gear	s = Not use when a filter valve			
7	1	13018	Idler Pinion				
8	1	13312	Spring, Idler				
9	1	13164	Drive Gear				
11	1	13170	Main Gear and Shaft				
12	1	19205	24-hour Gear Assembly, Silver				
	1	19205-01	24-hour Gear Assembly, Tan				
13	1	13011	Cycle Actuator Gear				
14	1	14177	Knob, Manual Regeneration				
15	4	13300	Ball, 1/4" Dia.				
16	2	13311	Spring, Detent, Skipper Wheel				
19	1	14381	Skipper Wheel Assembly, 12-day				
	1	14860	Skipper Wheel Assembly, 7-day				
20	1	13864	Skipper Wheel Ring				
21	2	19080	Spring, Compression, 6700				
22	1	13014	Regeneration Pointer				
23	1	11842	Electrical Cord, Standard				
24	2	12681	Wire Connector (not shown)				
25	1	13547	Strain Relief				
26	1	40338	Back Cover				
27	1	13309	Front Label, Brown on Beige				
	1	13437	Front Label, Blue/Silver on Black				
28	1	13310	Rear Label, Softener				
	1	18520	Rear Label, Filter				
29	1	13348	Tape Stripe, Brown on Beige				
	1	13436	Tape Stripe, Blue on Silver				
30s	1	60514	Brine Cam Assembly, 3-18				
	1	60514-01	Brine Cam Assembly, 6-36				
	1	60514-02	Brine Cam Assembly, Minutes				
34	2	12473	Screw-drive Mounting				
35s	1	12037	Washer				
37	1	15151	Screw, Knob				
38	1	14176	Valve Position Dial,				

MODEL 5600 CONTROL VALVE DRIVE ASSEMBLY

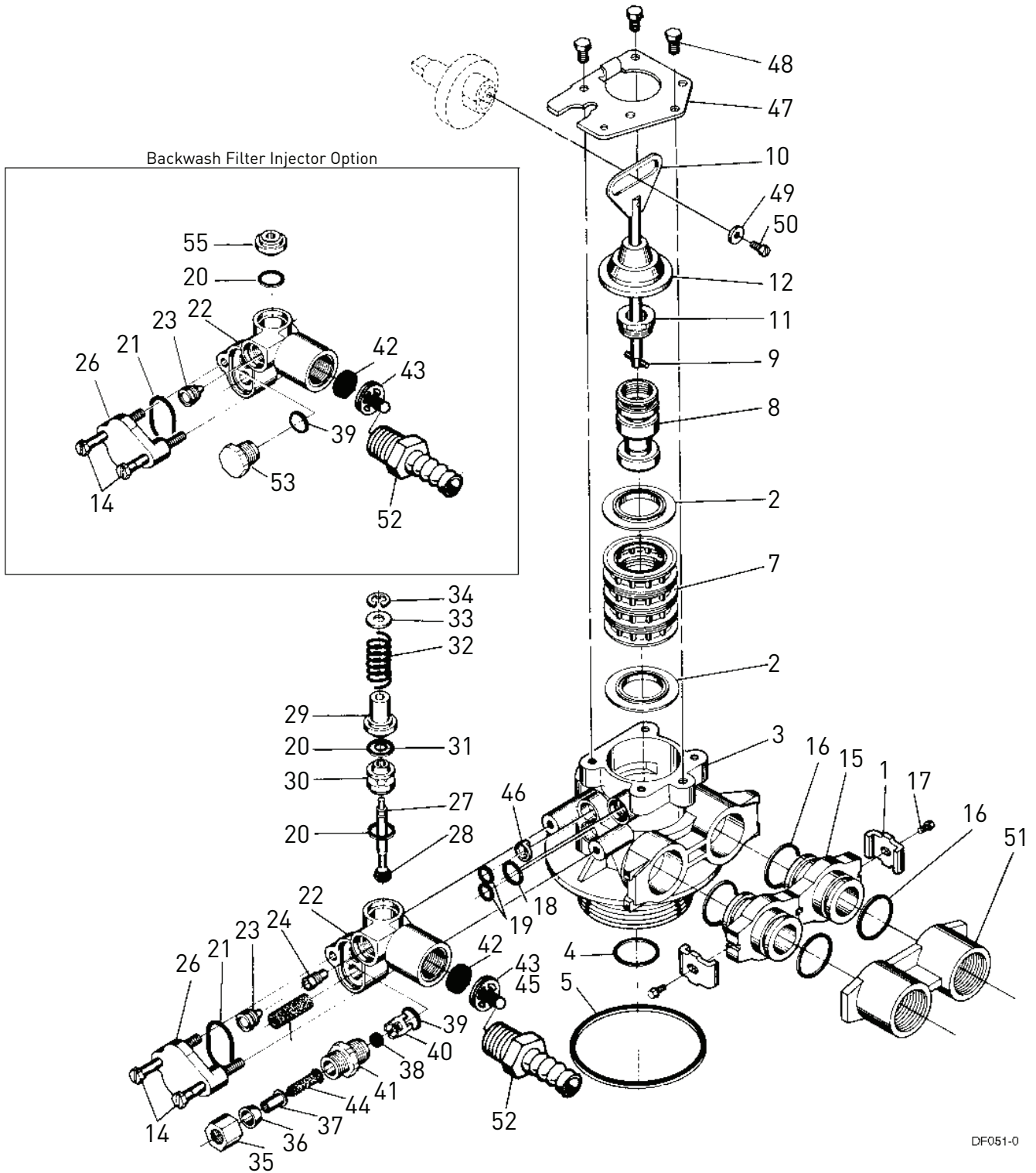

DF051-0

MODEL 5600 CONTROL VALVE DRIVE ASSEMBLY *CONTINUED*

Item No.	QTY	Part No.	Description	Item No.	QTY	Part No.	Description
1	2-4	13255	Adapter Clip (Clock or Meter)	38	1	12094	BLFC Button, .25 gpm
2	5	13242	Seal		1	12095	BLFC Button, .50 gpm
	5	17772	Silicone Seal		1	12097	BLFC Button, 1.0 gpm
3	1	61400-12	Valve Body Assembly, 1" Dist.	39s	1	12977	O-ring, BLFC
	1	61400-11	Valve Body Assembly, 3/4" Dist.	40	1	13245	BLFC Button Retainer
4	1	13304	O-ring, Distributor Tube, 1"	41	1	13244	BLFC Fitting, 3/8"
	1	10244	O-ring, Distributor Tube, 13/16"	42	1	00000	DLFC Button, Specify Size
5	1	12281	O-ring, Top of Tank	43	1	13173	DLFC Button Retainer
7	4	14241	Spacer	44	1	12767	Screen, Brine Line
8	1	13247	Piston, Standard	45	1	15348	O-ring, DLFC (not shown)
	1	43216	Piston, Low Water	46	1	13497	Air Disperser
	1	13852	Piston, Filter	47	1	13546	End Plug Retainer
9	1	10696	Piston Pin	48	3	12112	Screw
10	1	13001	Piston Rod Assembly	49	1	13363	Washer
11	1	12953	Piston Retainer	50	1	13296	Screw
12	1	13446	End Plug Assembly Standard, White	51A	1	13398	Yoke, Brass, 1" NPT
	1	13446-10	End Plug Assembly Filter, Black		1	13708	Yoke, Brass, 3/4" NPT
13	1	13446-20	End Plug Assembly Low Water, Gray	51B	1	18706	Yoke, Plastic, 1" NPT
					1	18706-02	Yoke, Plastic 3/4" NPT
14	2	13315	Screw, Injector Mounting	52	1	13308	Drain Hose Barb
15	2	19228	Adapter Coupling	53	1	13918	BLFC, Plug
16*	4	13305	O-ring, Adapter Coupling	54s	1	13857	Brine Valve, Plug
17*	2-4	13314	Screw, Adapter Coupling (Clock or Meter)				
18	1	12638	O-ring, Drain				
19	2	13301	O-ring, Injector				
20s	2	13302	O-ring, Brine Spacer				
21	1	13303	O-ring, Injector Cover				
22	1	13163	Injector Body				
23s	1	10913U	Injector Nozzle, Undrilled				
24	1	10914	Injector Throat, Specify Size				
25	1	10227	Injector Screen				
26	1	13166	Injector Cover				
27	1	13172	Brine Valve Stem				
28	1	12626	Brine Valve Seat				
29	1	13165	Brine Valve Cap				
30	1	13167	Brine Valve Spacer				
31	1	12550	Quad Ring				
32	1	11973	Spring, Brine Valve				
33	1	16098	Washer, Brine Valve				
34	1	11981-01	Retaining Ring				
35	1	10329	BLFC Fitting Nut				
36	1	10330	BLFC Ferrule				
37	1	10332	BLFC Tube Insert				

*not used with meter controls

s = used in backwash filter

MODEL 5600 CONTROL VALVE DRIVE ASSEMBLY

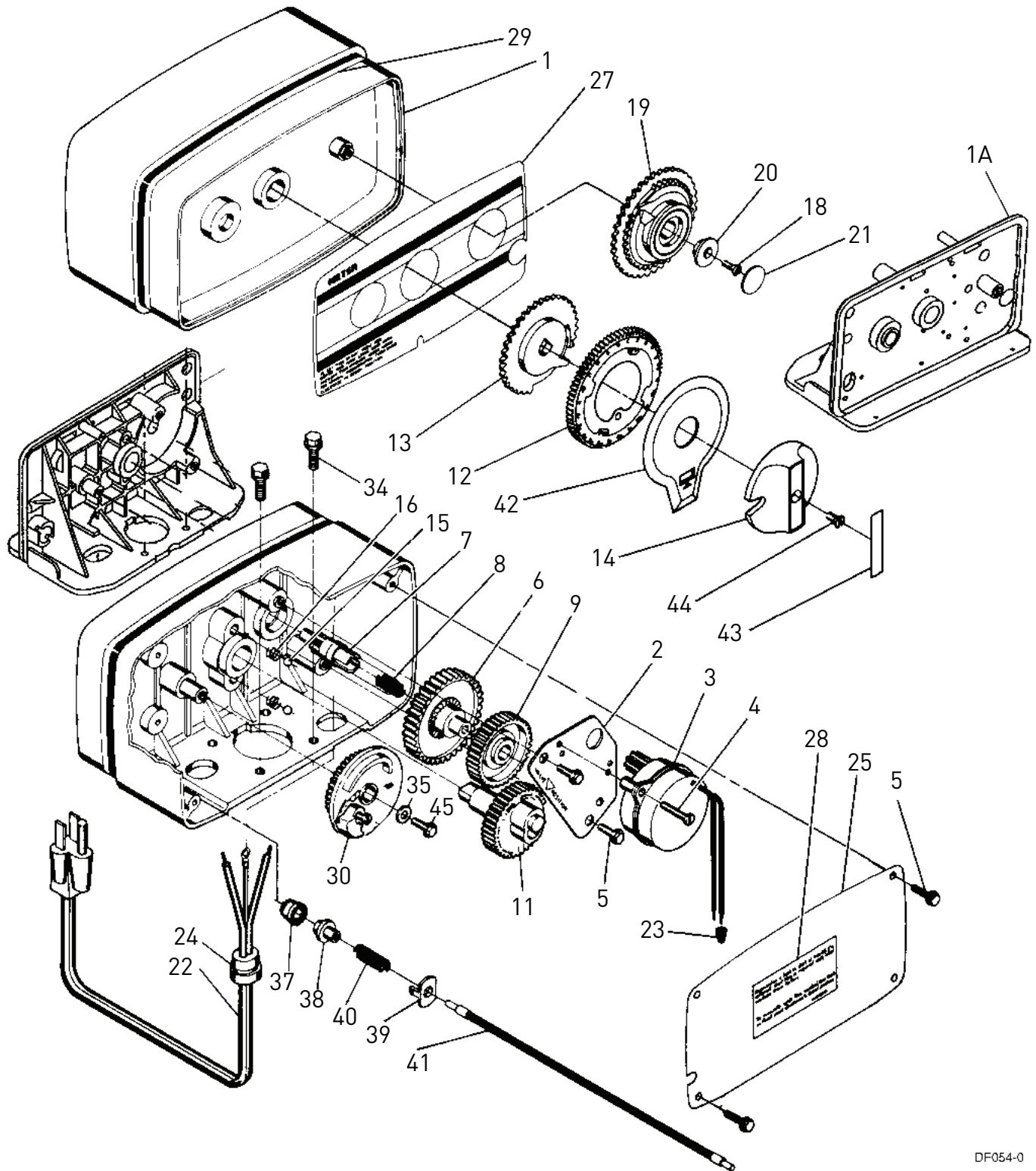

DF054-0

MODEL 5600 CONTROL VALVE DRIVE ASSEMBLY *CONTINUED*

Item No.	QTY	Part No.	Description	Item No.	QTY	Part No.	Description
1	1	14488-001	Drive Housing, with Pin Drilled for Cover	42	1	14176	Valve Position Dial, Standard
1A	1	15494-03	"L" Housing, with Pin Drilled for Designer		1	14278	Valve Position Dial, Low Water
2	1	13175	Motor Mounting Plate		1	15478	Valve Position Dial, Filter
3	1	18743	Motor, 120V, 60 Hz	43	1	14175	Knob Label, Beige
	1	13494	Motor, 24V, 60 Hz		1	14207	Knob Label, Silver
4	2-3	11384	Screw, Motor Mtg. and Ground Wire	44	1	15151	Screw, Knob
5	2-4	13296	Screw, Component Mounting	45	1	40214	Screw, Brine Cam
6	1	13017	Idler Gear				
7	1	13018	Idler Pinion				
8	1	13312	Spring, Idler				
9	1	13164	Drive Gear				
11	1	13170	Main Gear and Shaft				
12	1	19205	24-hour Gear Assembly, Silver				
	1	19205-01	24-hour Gear Assembly, Tan				
13	1	13802	Cycle Actuator Gear				
14	1	14177	Knob, Manual Regeneration				
15	2	13300	Ball, 1/4" Dia.				
16	2	19080	Spring, Compression, 6700				
18	1	13748	Screw, Program Wheel				
19	1	60405-15	Program Skipper Wheel Assembly, Specify Hardness Capacity				
20	1	13806	Program Wheel Retainer				
21	1	13953	Cover Label, Program Wheel				
22	1	11842	Electrical Cord				
23	2	12681	Wire Connector				
24	1	13547	Strain Relief				
25	1	40338	Back Cover				
27	1	13955	Front Label, Beige				
	1	13958	Front Label, Silver				
28	1	13310	Rear Label, Softener				
	1	18520	Rear Label, Filter				
29	1	13957	Tape Stripe, Beige				
	1	13960	Tape Stripe, Silver				
30	1	60514	Brine Cam Assembly, 3-18				
	1	60514-01	Brine Cam Assembly, 6-36				
	1	60514-02	Brine Cam Assembly, Minutes				
34	2	12473	Screw-drive Mounting				
35	1	12037	Washer				
37	1	13830	Drive Pinion, Program Wheel				
38	1	13831	Clutch, Drive Pinion				
39	1	14253	Spring Retainer				
40	1	14276	Spring				
41	1	14043	Cable Assembly, Standard				
	1	14910	Cable Assembly, Extended, Right Angle				

5600 ELECTROMECHANICAL

Softener Time Clock

Item No.	QTY	Part No.	Description
1.....	1.....	560001-003.....	5600, SOF, DFN, CLK, 12DA, 12060, CW 1-- , .50, LES, NA2, 1600, SOFT
	560001-004.....	5600, SOF, DFN, CLK, 12DA, 24-60, CW 1-- , .25, LES, NA2, 1600, SOFT
	560001-005.....	5600, SOF, DFN, CLK, 12DA, 12060, CW 1-- , .50, LES, NA2, 1600, SOFT
	560001-006.....	5600, SOF, DFN, CLK, 12DA, 24-60, CW 1-- , .50, LES, NA2, 1600, SOFT
	560001-007.....	5600, SOF, DFN, CLK, 12DA, 12060, CW 1-- , .50, LES, NA2, 1600, SOFT
	560001-009.....	5600, SOF, DFN, CLK, 12DA, 12060, CW 1-- , .50, LES, NA2, 1600, SOFT
	560001-013.....	5600, SOF, DFN, CLK, 12DA, 12060, CW 1-- , .25, LES, NA2, 1600, SOFT

Filter Time Clock

Item No.	QTY	Part No.	Description
1.....	1.....	560000-001.....	5600, FIL, DFN, CLK, 7DAY, 12060, CW BWF, BWF, LES, NA2, BWF-, FILT
	560001-001.....	5600, FIL, DFN, CLK, 12DA, 12060, CW BWF, BWF, LES, NA2, BWF-, FILT
	560001-002.....	5600, FIL, DFN, CLK, 12DA, 12060, CW BWF, BWF, LES, NA2, BWF-, FILT
	560001-008.....	5600, FIL, DFN, CLK, 12DA, 22050, CW BWF, BWF, LES, NA2, BWF-, FILT
	560001-010.....	5600, FIL, DFN, CLK, 12DA, 12060, CW BWF, BWF, LES, NA2, BWF-, FILT
	560001-012.....	5600, FIL, DFN, CLK, 12DA, 12060, CW BWF, BWF, LES, NA2, BWF-, FILT

Softener Meter

Item No.	QTY	Part No.	Description
1.....	1.....	560002-001.....	5600, SOF, DFN, M34, MDEL, 12060, CW 1-- , .50, LES, NA2, 1600, SOFT
	560002-002.....	5600, SOF, DFN, M34, MDEL, 24-60, CW 1-- , .50, LES, NA2, 1600, SOFT
	560002-003.....	5600, SOF, DFN, M34, MDEL, 12060, CW 1-- , .50, LES, NA2, 1600, SOFT
	560002-004.....	5600, SOF, DFN, M34, MDEL, 24-60, CW 1-- , .50, LES, NA2, 1600, SOFT
	560002-005.....	5600, SOF, DFN, M34, MDEL, 12060, CW 1-- , .50, LES, NA2, 1600, SOFT
	560002-006.....	5600, SOF, DFN, M34, MDEL, 12060, CW 1-- , .50, LES, NA2, 1600, LWAT
	560002-007.....	5600, SOF, DFN, M34, MDEL, 12060, CW 1-- , .50, LES, NA2, 1600, LWAT
	560002-008.....	5600, SOF, DFN, M34, MDEL, 24-60, CW 1-- , .50, LES, NA2, 1600, LWAT
	560002-009.....	5600, SOF, DFN, M34, MDEL, 24-60, CW 1-- , .50, LES, NA2, 1600, LWAT
	560002-010.....	5600, SOF, DFN, M34, MDEL, 12060, CW 1-- , .50, LES, NA2, 1600, SOFT
	560002-011.....	5600, SOF, DFN, M34, MDEL, 12060, CW 1-- , .50, LES, NA2, 1600, SOFT

NOTE: Above part numbers DO NOT include the following parts.

Cover
 Bypass Assembly
 Yoke Assembly
 DLFC with Retainer
 Flow Washers
 Transformer*

See accessory page for options.
 *See ordering guide for details.

5600 VALVE ACCESSORIES

Covers

- 13753-02 Cover, 5600, Black
- 42345-03 Cover, 5600, Mechanical, Smoke
- 42345-04 Cover, 5600, Mechanical, Transparent Blue
- 60226-11..... Cover, 5600, Designer I, Blk/Blk
- 60226-22 Cover, 5600, Designer I, Blue/Blue

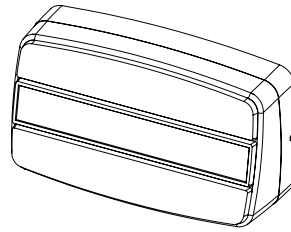

COVER

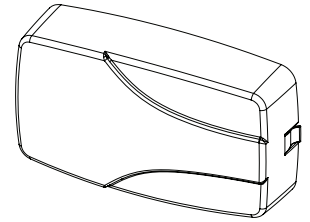

COVER, MECHANICAL

Bypasses

- 60041SS 1" Bypass, SS, NPT
- 60040SS 3/4" Bypass, SS, NPT
- 60049..... Bypass, Plastic

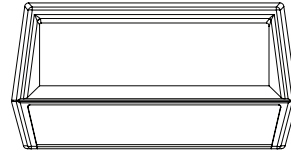

COVER, DESIGNER

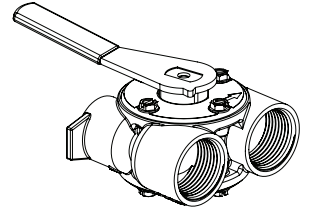

BYPASS

Yokes

- 19620-01..... Yoke Assy, 3/4", r/angle, 90 deg.
- 18706..... 1" Yoke, Plastic NPT
- 18706-10..... 1" Yoke, Plastic BSP
- 18706-02 3/4" Yoke, Plastic NPT
- 18706-12 3/4" Yoke, Plastic BSP
- 61694..... 1" Yoke, QC
- 61700..... 3/4" Yoke, QC
- 13708-40 1" Yoke, Sweat
- 41026-01..... 1" Yoke, SS, NPT
- 42690..... 3/4" Yoke, Sweat
- 41027-01 3/4" Yoke, SS, NPT

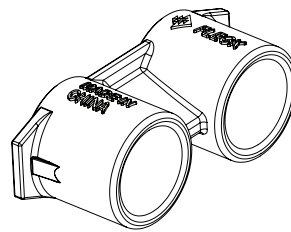

YOKE

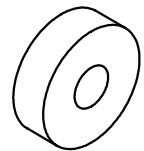

WASHER

Washers

- 19153 Washer, Flow, 0.6 GPM
- 19152 Washer, Flow, 0.8 GPM
- 12085 Washer, Flow, 1.2 GPM
- 19150 Washer, Flow, 1.3 GPM
- 12086 Washer, Flow, 1.5 GPM
- 19149 Washer, Flow, 1.7 GPM
- 12087..... Washer, Flow, 2.0 GPM
- 12088 Washer, Flow, 2.4 GPM
- 12089 Washer, Flow, 3.0 GPM
- 12090 Washer, Flow, 3.5 GPM
- 12091..... Washer, Flow, 4.0 GPM
- 19147 Washer, Flow, 4.5 GPM
- 12092 Washer, Flow, 5.0 GPM
- 17814..... Washer, Flow, 6.0 GPM
- 12408 Washer, Flow, 7.0 GPM

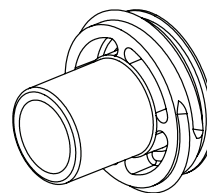

RETAINER

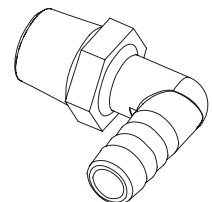

DRAIN ELBOW

Retainer

- 13173-01..... Retainer, DLFC Button, w/O-ring

Drain Elbows

- 12338..... 1/2" Drain Elbow, 90
- 19699..... 1/2" Drain Elbow, 45
- 13121..... 5/8" Drain Elbow, 90

Hose Barbs

- 13308..... 1/2" Straight Hose Barb
- 13308-01..... 5/8" Straight Hose Barb

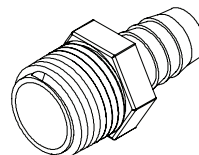

HOSE BARBS

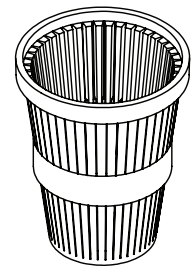

COLLECTOR

Collectors

- 18280 Top Collector, 1.050
- 18280-02 Top Collector, 1.050 Narrow
- 18280-01..... Top Collector, 1.050 Wide

5600 VALVE ASSEMBLIES

BLFC

60022-12	BLFC, 0.125 GPM (0.375 lbs NaCl/min)
60022-25	BLFC, 0.25 GPM (0.75 lbs NaCl/min)
60022-50	BLFC, 0.50 GPM (1.5 lbs NaCl/min)
60022-100	BLFC, 1.0 GPM (3 lbs NaCl/min)

Injector Drain Assemblies

60084-0001	Injector Drain Assy, 5600, #0, Blank DLFC, .25 BLFC
60084-0002	Injector Drain Assy, 5600, #0, Blank DLFC, .50 BLFC
60084-0101	Injector Drain Assy, 5600, #1, Blank DLFC, .25 BLFC
60084-0102	Injector Drain Assy, 5600, #1, Blank DLFC, .50 BLFC

Injector Assembly

60384-0	Injector Assy, Filter, 5600, Blank DLFC
---------	---

Injector Nozzles

10913-0	Nozzle, Injector, #0, Red (8" Tank)
10913-00	Nozzle, Injector, #00, Violet (7" Tank)
10913-000	Nozzle, Injector, #000, Brown (6" Tank)
10913-1	Nozzle, Injector, #1, White (9" & 10" Tank)
10913-2	Nozzle, Injector, #2, Blue (12" Tank)
10913-3	Nozzle, Injector, #3, Yellow (13" Tank)
10913-4	Nozzle, Injector, #4, Green (14" Tank)
10913BLK	Nozzle, Injector, Black (Filter)

Injector Throats

10914-0	Throat, Injector, #0, Red (8" Tank)
10914-00	Throat, Injector, #00, Violet (7" Tank)
10914-000	Throat, Injector, #000, Brown (6" Tank)
10914-1	Throat, Injector, #1, White (9" & 10" Tank)
10914-2	Throat, Injector, #2, Blue (12" Tank)
10914-3	Throat, Injector, #3, Yellow (13" Tank)
10914-4	Throat, Injector, #4, Green (14" Tank)

Plugs

40947-02	Plug, Brine Valve, w/o-ring
----------	-----------------------------

BLFC Module Plug Assembly

13918-01	BLFC Module Plug Assy, w/o-ring
----------	---------------------------------

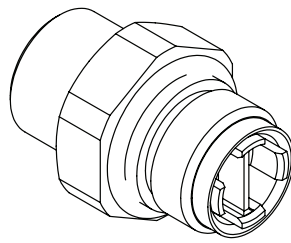

BLFC

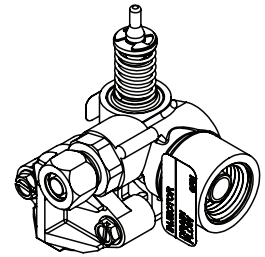

INJECTOR DRAIN ASSY

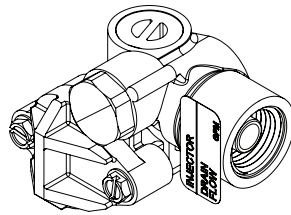

INJECTOR ASSEMBLY

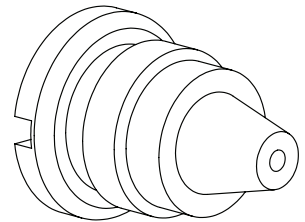

INJECTOR NOZZLE

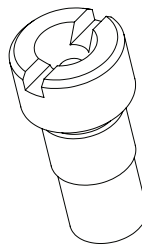

INJECTOR THROAT

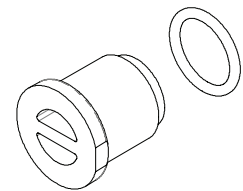

PLUG

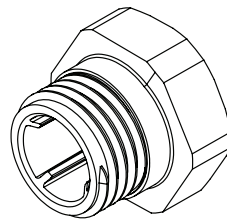

BLFC MODULE PLUG ASSY

5600 VALVE ASSEMBLIES

Labels

- 14213 Label, 11.5K
- 14214 Label, 13K
- 14343 Label, 15K
- 14076 Label, 16K
- 13969 Label, 18K
- 14046 Label, 21K
- 13961 Label, 24K
- 14237 Label, 24K, Black
- 14047 Label, 26K
- 14180 Label, 28K
- 13962 Label, 30K
- 14048 Label, 32K
- 13971 Label, 36K
- 14073 Label, 40K
- 14181 Label, 42K
- 13974 Label, 45K
- 14239 Label, 48K
- 14074 Label, 50K
- 14182 Label, 56K
- 14034 Label, 60K
- 14183 Label, 70K
- 18663 Label, Brine Valve Cam, 1.5-8 Lbs.
- 41124 Label, Lbs. Salt, 3-16
- 41125 Label, Lbs. Salt, 6-32
- 41126 Label, Brine Valve Cam, Minute
- 41127 Label, Brine Valve Cam, 1.5-7kg
- 41128 Label, Brine Valve Cam, 3-14kg

Switches

- 60320-03 Switch Assy, 5600 Auxiliary

Brine Cam Assemblies

- 60514-00 Brine Cam Assy, 5600, Less Salt Label

Meters

- 60086 Meter Assy, 3/4" Dual Port, Slip Std, Plas, Pdl, w/Clps
- 14043 Meter Cable , 8.25"
- 60088-180 Meter Assy, 3/4" Dual Port, Slip Std, Rt Ang/180, Plas, Pdl, w/clps
- 60089-180 Meter Assy, 3/4" Dual Port, Slip Ext, Rt Ang/180, Plas, Pdl, w/clps
- 14910 Meter Cable , 6.75"

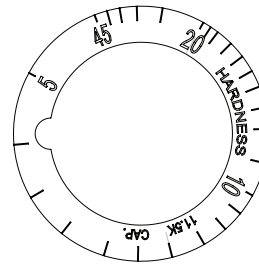

LABEL, HARDNESS

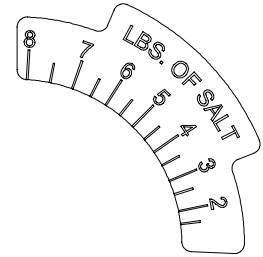

LABEL, LBS. OF SALT

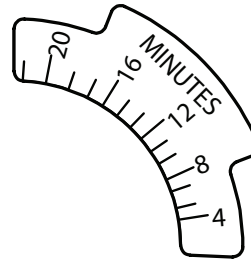

LABEL, MINUTES

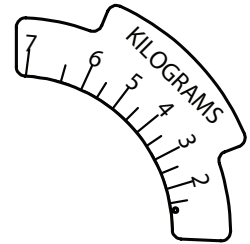

LABEL, KILOGRAMS

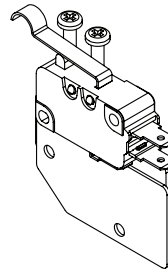

SWITCH

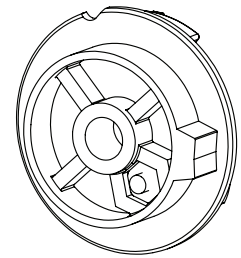

BRINE CAM ASSY

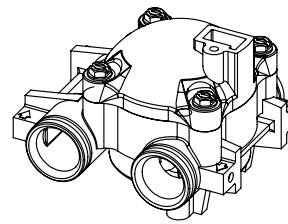

METER ASSY, PADDLE

5600 VALVE ASSEMBLIES *CONTINUED*

Powerheads

62089-01	Pwrhd, 5600, Soft, Mtr, Srng, Encl, Orange, 120/60, US Cord
62089-02	Pwrhd, 5600, Soft, Mtr, Srng, Encl, Sil/Blu, 24/60, XFMR120/24
62089-03	Pwrhd, 5600, Soft, Mtr, Srng, Encl, Sil/Blu, 120/60, US Cord
62089-04	Pwrhd, 5600, Soft, Mtr, Srng, Encl, Sil/Blu, 24/60, No Cord
62089-05	Pwrhd, 5600, Soft, Mtr, Srng, "L", Orange, 120/60, US Cord
62089-06	Pwrhd, 5600, Soft, Mtr, Srng, "L", Sil/Blk, 120/60, US Cord
62089-07.....	Pwrhd, 5600, Soft, Mtr, Srng, "L", Sil/Blk, 24/60, No Cord
62089-08	Pwrhd, 5600, Soft, Mtr, Xrng, "L", Sil/Blu, 120/60, US Cord
62089-09	Pwrhd, 5600, Soft, Mtr, Srng, "L", Sil/Blu, 120/60, US Cord
62089-10	Pwrhd, 5600, Soft, Mtr, Srng, "L", Sil/Blu, 24/60, No Cord
62089-11.....	Pwrhd, 5600, Soft, Mtr, Srng, "L", Sil/Blu, XFMR120/24, No Cord
62090-01	Pwrhd, 5600, Soft, Clk, 12D, Encl, Sil/Blu, 120/60, US Cord
62090-02	Pwrhd, 5600, Soft, Clk, 12D, Encl, Sil/Blu, 24/60, No Cord
62090-03	Pwrhd, 5600, Soft, Clk, 12D, Encl, Tan, 120/60, US Cord
62090-04	Pwrhd, 4650/5600, Soft, Clk, 12D, "L", Sil/Blk, 120/60, US Cord
62090-05	Pwrhd, 4650/5600, Soft, Clk, 12D, "L", Sil/Blk, 24/60, No Cord
62091-01.....	Pwrhd, 5600, Filt, Clk, 12D, Encl, Sil/Blu, 120/60, US Cord
62091-02	Pwrhd, 5600, Filt, Clk, 12D, "L", Sil/Blk, 120/60, US Cord
62091-03	Pwrhd, 5600, Filt, Clk, 35D, "L", Sil/Blk, 120/60, US Cord
62091-04	Pwrhd, 5600, Filt, Clk, 35D, "L", Sil/Blk, 24/60, No Cord
62091-05	Pwrhd, 5600, Filt, Clk, 35D, "L", Sil/Blk, 24/60, XFMR120/24

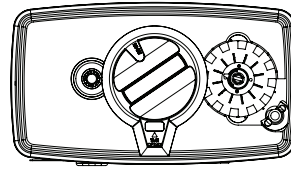

POWERHEAD

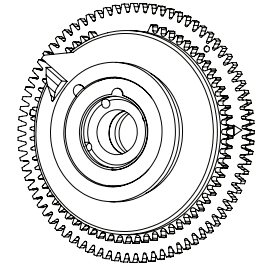

PROGRAM WHEEL

Program Wheels

60405-10	Program Wheel, w/3/4" Standard Label (0-2,100 Gallons)
60405-11.....	Program Wheel, Extended Metric (0 - 8 M3)
60405-15	Program Wheel, w/3/4" Standard Label w/People Label
60405-20	Program Wheel, w/3/4" Extended Label (0-10, 500 Gallons)
60405-21	Program Wheel, Extended Metric (0 - 40 M3)

SERVICE INSTRUCTIONS

Replace Time Brine Valve, Injectors and Screen

1. Unplug electrical cord from outlet.
2. Turn off water supply to conditioner:
 - C.If the conditioner installation has a “three valve” bypass system, first open the valve in the bypass line, then close the valves at the conditioner inlet and outlet.
 - D. If the conditioner has an integral bypass valve, put it in the **Bypass** position.
 - E. If there is only a shut-off valve near the conditioner inlet, close it.
3. Relieve water pressure in the conditioner by putting the control in the **Backwash** position momentarily. Return the control to the **In Service** position.
4. Disconnect brine tube and drain line connections at the injector body.
5. Remove the two injector body mounting screws. The injector and brine module can now be removed from the control valve. Remove and discard valve body O-rings.
6. Replace brine valve.
 - A. Pull brine valve from injector body, also remove and discard O-ring at bottom of brine valve hole.
 - B. Apply silicone lubricant to new O-ring and reinstall at bottom of brine valve hole.
 - C.Apply silicone lubricant to O-ring on new valve assembly and press into brine valve hole, shoulder on bushing should be flush with injector body.
7. Replace injectors and screen.
 - A. Remove injector cap and screen, discard O-ring. Unscrew injector nozzle and throat from injector body.
 - B. Screw in new injector throat and nozzle, be sure they are seated tightly. Install a new screen.
 - C.Apply silicone lubricant to new O-ring and install around oval extension on injector cap.
8. Apply silicone lubricant to three new O-rings and install over three bosses on injector body.
9. Insert screws with washers through injector cap and injector. Place this assembly through hole in timer housing and into mating holes in the valve body. Tighten screws. (Be sure to reinstall brass spacers with injector on model **4600** valve.)
10. Reconnect brine tube and drain line.
11. Return bypass or inlet valving to normal **In Service** position. Water pressure automatically builds in the conditioner.

NOTE: Be sure to shut off any bypass line.

12. Check for leaks at all seal areas. Check drain seal with the control in the **Backwash** position.
13. Plug electrical cord into outlet.
14. Set time of day and cycle the control valve manually to assure proper function.
 - A. Make sure control valve is in the **In Service** position.
15. Make sure there is enough brine in the brine tank.
16. Rotate program wheel counterclockwise until it stops at **Regeneration** position.
17. Start regeneration cycle manually if water is hard.

Replace Timer

1. Unplug electrical cord from outlet.
 2. Turn off water supply to conditioner:
 - A. If the conditioner installation has a “three valve” bypass system, first open the valve in the bypass line, then close the valves at the conditioner inlet and outlet.
 - B. If the conditioner has an integral bypass valve, put it in the **Bypass** position.
 - C.If there is only a shut-off valve near the conditioner inlet, close it.
 3. Relieve water pressure in the conditioner by putting the control in the **Backwash** position momentarily. Return the control to the **In Service** position.
 4. Pull cable out of meter cover. Remove the control valve back cover.
 5. Remove screw and washer at drive yoke. Remove timer mounting screws. The entire timer assembly now lifts off easily.
 6. Put new timer on top of valve. Be sure drive pin on main gear engages slot in drive yoke (rotate control knob if necessary).
 7. Replace timer mounting screws. Replace screw and washer at drive yoke.
 8. Return bypass or inlet valving to normal **In Service** position. Water pressure automatically builds in the conditioner.
- NOTE: Be sure to shut off any bypass line.**
9. Plug electrical cord into outlet.
 10. Set time of day, program wheel, and salt usage. Cycle the control valve manually to assure proper function. Be sure to return the control valve to the **In Service** position.
 11. Replace the control valve back cover. Be sure grommet at cable hole is in place.
 12. Make sure there is enough brine in the brine tank.
 13. Rotate program wheel counterclockwise until it stops at **Regeneration** position.
 14. Start regeneration cycle manually if water is hard.
 15. Plug cable into meter cover, rotate cable to align drive flat if necessary.

Replace Piston Assembly

1. Unplug electrical cord from outlet.
2. Turn off water supply to conditioner:
 - A. If the conditioner installation has a "three valve" bypass system, first open the valve in the bypass line, then close the valves at the conditioner inlet and outlet.
 - B. If the conditioner has an integral bypass valve, put it in the **Bypass** position.
 - C. If there is only a shut-off valve near the conditioner inlet, close it.
3. Relieve water pressure in the conditioner by putting the control in the **Backwash** position momentarily. Return the control to the **In Service** position.
4. Pull cable out of meter cover. Remove the control valve back cover.
5. Remove screw and washer at drive yoke. Remove timer mounting screws. The entire timer assembly now lifts off easily. Remove end plug retainer plate.
6. Pull upward on end of piston yoke until assembly is out of valve.
7. Inspect the inside of the valve to make sure that all spacers and seals are in place, and that there is no foreign matter that would interfere with the valve operation.
8. Take new piston assembly as furnished and push piston into valve by means of the end plug. Twist yoke carefully in a clockwise direction to properly align it with drive gear. Replace end plug retainer plate.
9. Place timer on top of valve. Be sure drive pin on main gear engages slot in drive yoke (rotate control knob if necessary).
10. Replace timer mounting screws. Replace screw and washer at drive yoke.
11. Return bypass or inlet valving to normal **In Service** position. Water pressure automatically builds in the conditioner.

NOTE: Be sure to shut off any bypass line.

12. Plug electrical cord into outlet.
13. Set time of day, program wheel, and salt usage. Cycle the control valve manually to assure proper function. Be sure to return the control valve to the **In Service** position.
14. Replace the control valve back cover. Be sure grommet at cable hole is in place.
15. Make sure there is enough brine in the brine tank.
16. Rotate program wheel counterclockwise until it stops at **Regeneration** position.
17. Start regeneration cycle manually if water is hard.
18. Plug cable into meter cover. Rotate cable to align drive flat if necessary.

Replace Seals and Spacers

1. Unplug electrical cord from outlet.
2. Turn off water supply to conditioner.
 - A. If the conditioner installation has a "three valve" bypass system, first open the valve in the bypass line, then close the valves at the conditioner inlet and outlet.
 - B. If the conditioner has an integral bypass valve, put it in the **Bypass** position.
 - C. If there is only a shut-off valve near the conditioner inlet, close it.

3. Relieve water pressure in the conditioner by putting the control in the **Backwash** position momentarily. Return the control to the **In Service** position.
4. Pull cable out of meter cover. Remove the control valve back cover.
5. Remove screw and washer at drive yoke. Remove timer mounting screws. The entire timer assembly now lifts off easily. Remove end plug retainer plate.
6. Pull upward on end of piston rod yoke until assembly is out of valve. Remove and replace seals and spacers with fingers.

Replace Meter

1. Unplug electrical cord from outlet.
2. Turn off water supply to conditioner:
 - A. If the conditioner installation has a "three valve" bypass system, first open the valve in the bypass line, then close the valves at the conditioner inlet and outlet.
 - B. If the conditioner has an integral bypass valve, put it in the **Bypass** position.
 - C. If there is only a shut-off valve near the conditioner inlet, close it.
3. Relieve water pressure in the conditioner by putting the control in the **Backwash** position momentarily. Return the control to the **In Service** position.
4. Pull cable out of meter cover.
5. Remove two screws and clips at bypass valve or yoke. Pull resin tank away from plumbing connections.
6. Remove two screws and clips at control valve. Pull meter module out of control valve.
7. Apply silicone lubricant to four new O-rings and assemble to four ports on new meter module.
8. Assemble meter to control valve. Note, meter portion of module must be assembled at valve outlet.
9. Attach two clips and screws at control valve. Be sure clip legs are firmly engaged with lugs.
10. Push resin tank back to the plumbing connections and engage meter ports with bypass valve or yoke.
11. Attach two clips and screws at bypass valve or yoke. Be sure clip legs are firmly engaged with lugs.
12. Return bypass or inlet valving to normal **In Service** position. Water pressure automatically builds in the conditioner.

NOTE: Be sure to shut off any bypass line.

13. Check for leaks at all seal areas.
14. Plug electrical cord into outlet.
15. Set time of day.
 - A. Make sure control valve is in the **In Service** position.
16. Rotate program wheel counterclockwise until it stops at **Regeneration** position.
17. Start regeneration cycle manually if water is hard.
18. Plug cable into meter cover. Rotate cable to align drive flat if necessary.

Replace Meter Cover and/or Impeller

1. Unplug electrical cord from outlet.
2. Turn off water supply to conditioner:
 - A. If the conditioner installation has a "three valve" bypass system, first open the valve in the bypass line, then close the valves at the conditioner inlet and outlet.
 - B. If the conditioner has an integral bypass valve, put it in the **Bypass** position.
 - C. If there is only a shut-off valve near the conditioner inlet, close it.
3. Relieve water pressure in the conditioner by putting the control in the **Backwash** position momentarily. Return the control to the **In Service** position.
4. Pull cable out of meter cover.
5. Remove four screws on cover.
6. Lift cover off of meter module, discard o-ring.
7. Remove and inspect impeller for gear or spindle damage, replace if necessary.
8. Apply silicone lubricant to new o-ring and assemble to the smallest diameter on meter cover.
9. Assemble cover to meter module. Be sure impeller spindle enters freely into cover. Press firmly on cover and rotate if necessary to assist in assembly.
10. Replace four screws and tighten.
11. Return bypass or inlet valving to normal **In Service** position. Water pressure automatically builds in the conditioner.

NOTE: Be sure to shut off any bypass line.

12. Check for leaks at all seal areas.
13. Plug electrical cord into outlet.
14. Set time of day
 - A. Make sure valve is in the **In Service** position.
15. Rotate program wheel counterclockwise until it stops at
16. position.
17. Start regeneration cycle manually if water is hard.
18. Plug cable into meter cover. Rotate cable to align drive flat if necessary.

TROUBLESHOOTING

Problem	Cause	Correction
1. Softener fails to regenerate.	A. Electrical service to unit has been interrupted.	A. Assure permanent electrical service (check fuse, plug, pull chain or switch).
	B. Timer is defective.	B. Replace timer.
	C. Power failure.	C. Reset time of day.
2. Softener delivers hard water.	A. Bypass valve is open.	A. Close bypass valve.
	B. No salt in brine tank.	B. Add salt to brine tank and maintain salt level above water level.
	C. Injectors or screen is plugged.	C. Replace injectors and screen.
	D. Insufficient water flowing into brine tank.	D. Check brine tank fill time and clean brine line flow control if plugged.
	E. Hot water tank hardness.	E. Repeated flushings of the hot water tank is required.
	F. Leak at distributor tube.	F. Make sure distributor tube is not cracked. Check O-ring and tube pilot.
	G. Internal valve leak.	G. Replace seals and spacers and/or piston.
3. Unit uses too much salt.	A. Improper salt setting.	A. Check salt usage and salt setting.
	B. Excess water in brine tank.	B. See problem number 7.
4. Loss of water pressure.	A. Iron build-up in line to water conditioner.	A. Clean line to water conditioner.
	B. Iron build-up in water conditioner.	B. Clean control and add resin cleaner to resin bed. Increase frequency of regeneration.
	C. Inlet of control plugged due to foreign material loose from pipes by recent work done on plumbing system.	C. Remove piston and clean control.
5. Loss of resin through drain line.	A. Air in water system.	A. Assure that well system has proper air elimination control, Check for dry well condition.
6. Iron in conditioned water.	A. Fouled resin bed.	A. Check backwash, brine draw and brine tank fill, increase frequency of regeneration, increase backwash time.
7. Excessive water in brine tank.	A. Plugged drain line flow control.	A. Clean flow control.
8. Salt water in service line.	A. Plugged injector system.	A. Clean injector and replace screen.
	B. Timer not cycling.	B. Replace timer.
	C. Foreign material in brine valve.	C. Clean or replace brine valve.
	D. Foreign material in brine line flow control.	D. Clean brine line flow control.
9. Softener fails to draw brine.	A. Draw line flow control is plugged.	A. Clean drain line flow control.
	B. Injector is plugged.	B. Clean or replace injectors.
	C. Injector screen plugged.	C. Replace screen.
	D. Line pressure is too low.	D. Increase line pressure (minimum 20 psi (1.3 bar) at all times).
	E. Internal control leak.	E. Change seals, spacers and/or piston assembly.
10. Control cycles continuously.	A. Faulty timer mechanism.	A. Replace timer.
11. Drain flows continuously.	A. Foreign material in control.	A. Remove piston assembly and inspect bore, remove foreign material and check control in various regeneration positions.
	B. Internal control leak.	B. Replace seals and/or piston assembly.
	C. Control valve jammed in Brine or Backwash position.	C. Replace seals and/or piston assembly.
	D. Timer motor stopped or jammed.	D. Replace timer.

GENERAL SERVICE HINTS FOR METER CONTROL

Problem	Cause	Correction
1. Softener delivers hard water.	A. Reserve capacity has been exceeded.	A. Check salt dosage requirements and reset program wheel to provide additional reserve.
	B. Program wheel is not rotating with meter output.	B. Pull cable out of meter cover and rotate manually, program wheel must move without binding and clutch must give positive "clicks" when program wheel strikes regeneration stop (if not, replace timer).
	C. Meter is not measuring flow.	C. Check output by observing rotation of small gear on front of timer (program wheel must not be against regeneration stop for this check) each tooth to tooth is approximately 30 gallons (113.5 L)(if not, replace meter).

MODEL 5600SF TROUBLESHOOTING

Problem	Cause	Correction
1. Filter fails to backwash.	A. Electrical service to unit has been interrupted.	A. Assure permanent electrical service (check fuse, plug, pull chain or switch).
	B. Timer is defective.	B. Replace timer.
	C. Power failure.	C. Reset time of day.
2. Filter "bleeds" iron.	A. Bypass valve is open.	A. Close bypass valve.
	B. Excessive water usage.	B. Reduce days between, backwashing (see timer instructions), make sure that there is not a leaking valve in the toilet bowl or sinks.
	C. Hot water tank rusty.	C. Repeated flushings of the hot water tank is required.
	D. Leak at distributor tube.	D. Make sure distributor tube is not cracked, check O-ring and tube pilot.
	E. Defective or stripped filter medium bed.	E. Replace bed.
	F. Inadequate backwash flow rate.	F. Make sure filter has correct drain flow control, be sure flow control is not clogged or drain line restricted, be sure water pressure has not dropped, increase backwash flow rate according to specifications for your unit, see your dealer for recommendations.
3. Loss of water pressure.	A. Iron or turbidity build-up in water filter.	A. Reduce days between backwashing so filter backwashes more often, make sure filter is sized large enough to handle water usage.
	B. Inlet plugged due to foreign material broken loose from pipes by recent work done on plumbing system.	B. Remove piston and clean control.
4. Loss of filter medium through drain line.	A. Broken or missing top screen.	A. Replace top screen, must have 0.020" wide slots.
5. Drain flows continuously.	A. Foreign material in control.	A. Remove piston assembly and inspect bore, remove foreign material and check control in various cycle positions.
	B. Internal control leak.	B. Replace seals and/or piston assembly.
	C. Control valve jammed in rinse or backwash.	C. Replace piston, seals and spacers (and drive motor if necessary).

[THIS PAGE LEFT INTENTIONALLY BLANK]

[THIS PAGE LEFT INTENTIONALLY BLANK]



For Pentair Fleck Product Warranties visit: pentair.com/assets/residential-filtration-warranty



13845 Bishops Dr. | Suite 200 | Brookfield, WI 53005 | United States
P: 262.238.4400 | Customer Service: 800.279.9404 | tech-support@pentair.com | pentair.com

All indicated Pentair trademarks and logos are property of Pentair. Third party registered and unregistered trademarks and logos are the property of their respective owners.
© 2021 Pentair. All rights reserved.

40106 REV N JA23