

TROJAN  UVMAX™

Owner's Manual

**DO NOT REMOVE FROM UNIT
See back cover for vital records**



ELECTRICAL SAFETY

GROUNDING

This product must be grounded. If it should malfunction or breakdown, grounding provides a path of least resistance for electric current to reduce the risk of electrical shock. This system is equipped with a cord having an equipment-grounding conductor and a grounding plug. The plug must be plugged into an appropriate outlet that is properly installed and grounded in accordance with all local codes and ordinances.

DANGER – Improper connection of the equipment-grounding conductor can result in a risk of electrocution. Check with a qualified electrician or service personnel if you are in doubt as to whether the outlet is properly grounded. Do not modify the plug provided with this system – if it will not fit the outlet, have a proper outlet installed by a qualified electrician. Do not use any type of adapter with this system.

GROUND FAULT CIRCUIT INTERRUPTER PROTECTION

To comply with the National Electrical Code (NFPA 70) and to provide additional protection from the risk of electric shock, this system should only be connected to a properly grounded, grounding-type power supply receptacle that is protected by a Ground Fault Circuit Interrupter (GFCI). Inspect operation of GFCI as per manufacturers suggested maintenance schedule.

EXTENSION CORDS

If an extension cord is necessary, use only 3-wire extension cords that have 3-prong grounding-type plugs and 3-pole cord connectors that accept the plug from this system. Use only extension cords that are intended for outdoor use. Use only extension cords having an electrical rating not less than the rating of the system. A cord rated for less amperes or watts than this system rating may overheat. Exercise caution when arranging the cord so that it will not be tripped over or pulled. Do not use damaged extension cords. Examine extension cord before using and replace if damaged. Do not abuse extension cord. Keep extension cord away from heat and sharp edges. Always disconnect the extension cord from the receptacle before disconnecting this system from the extension cord. Never yank cord to pull plug from outlet. Always grasp the plug and pull to disconnect.



WARNING – To prevent risk of electrical shock, connect this system only to a properly grounded, grounding-type power supply receptacle that is protected by a Ground Fault Circuit Interrupter. Pull plug before servicing or replacing lamp. Keep all connections dry and off the ground. Do not touch plug with wet hands.



WARNING – Do not look directly at UV lamp when it is operating. The light emitted by the lamp will cause serious eye damage and burn unprotected skin.



WARNING – Read manual before installing or servicing this system. Only authorized personnel possessing a strong understanding of this system should attempt to replace lamp or service this system.

NOTE – Maximum pressure rating is 125 PSI (861.8 kPa)

WARNING –

To guard against injury, basic safety precautions should be observed, including the following:

1. READ AND FOLLOW ALL SAFETY INSTRUCTIONS.
2. DANGER – To avoid possible electric shock, special care should be taken since water is employed in the use of this system. Do not attempt repairs yourself. No user serviceable parts. Return the system to an authorized service facility for service or discard the system.
3. Do not operate the system if it has a damaged cord or plug, or if it is malfunctioning or if it has been dropped or damaged in any manner.
4. Always unplug the system from an outlet before servicing or cleaning. Never yank cord to pull plug from outlet. Always grasp the plug and pull to disconnect.
5. Do not use the system for other than intended use. The use of attachments or accessories not recommended or sold by Trojan Technologies may cause an unsafe condition and/or reduce disinfection performance.
6. CAUTION – To prevent risk of electrical shock, connect this system only to a properly grounded, grounding-type power supply receptacle that is protected by a Ground Fault Circuit Interrupter (GFCI). Inspect performance of GFCI as per manufacturer's suggested maintenance schedule.
7. Visually inspect this system prior to installation. If the quartz sleeve or lamp is broken, cracked or damaged in any way, do not use. Contact Trojan Technologies Client Services for replacement parts.
8. WARNING – To reduce the risk of electrocution, keep all connections dry and off the ground. Do not touch plug with wet hands.
9. The light emitted by the lamp will cause serious eye damage and burn unprotected skin. Never look directly at the lamp when it is operating. Do not plug unit into an electrical outlet without properly securing the lamp/sleeve into the reaction chamber. Disconnect lamp harness before removing lamp from reactor.
10. If the UV system malfunctions or fails, water must be boiled prior to consumption until the UV system is operational and the water lines have been shocked. System failure is indicated by the system's audible alarm and absent (Models B & C) or red (all other models) indicator light.
11. Always shut off water flow and release water pressure before cleaning or maintaining unit.
12. Intended for indoor use only. Power supply must not be exposed to weather elements. In seasonal applications, reactor must be drained to prevent freezing.
13. Installation of this system must be in accordance with local plumbing and electrical codes as well as any and all applicable regulations and laws.
14. SAVE THESE INSTRUCTIONS.

Thank you.

By purchasing this system, you have taken the first step to providing safe drinking water for you and your family.

Designed using the most advanced UV technology available today, your UV system will operate with minimal maintenance and provide you with years of worry-free water disinfection. All you have to do is follow the information in this manual, conduct the recommended maintenance, and replace the lamp once a year.

Contents

Components	6
Product Specifications	8
Part Numbers	8
Water Quality Parameters	9
Additional Water Treatment Equipment	9
Installation	10
Operation	12
Service and Maintenance	14
Warranty	18
Troubleshooting	20

COMPONENTS

Each TrojanUVMax system comes with the following components.

One owner's manual



One warranty card



Reactor clamp(s)
One on Models A, B, C, D,
two on larger models



One power cord
Models D, E, F,
Pro7 and Pro15 only



One power supply



Model A



Power Cord — Lamp Cord

Models B and C

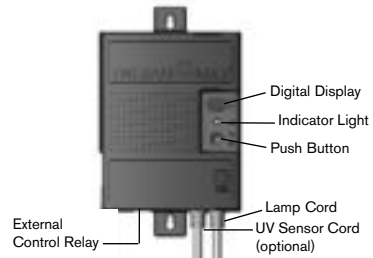

Models D, E, F, Pro7 & Pro15

One reactor; one lamp; one sleeve; one sleeve bolt; two O-rings; optional sensor.

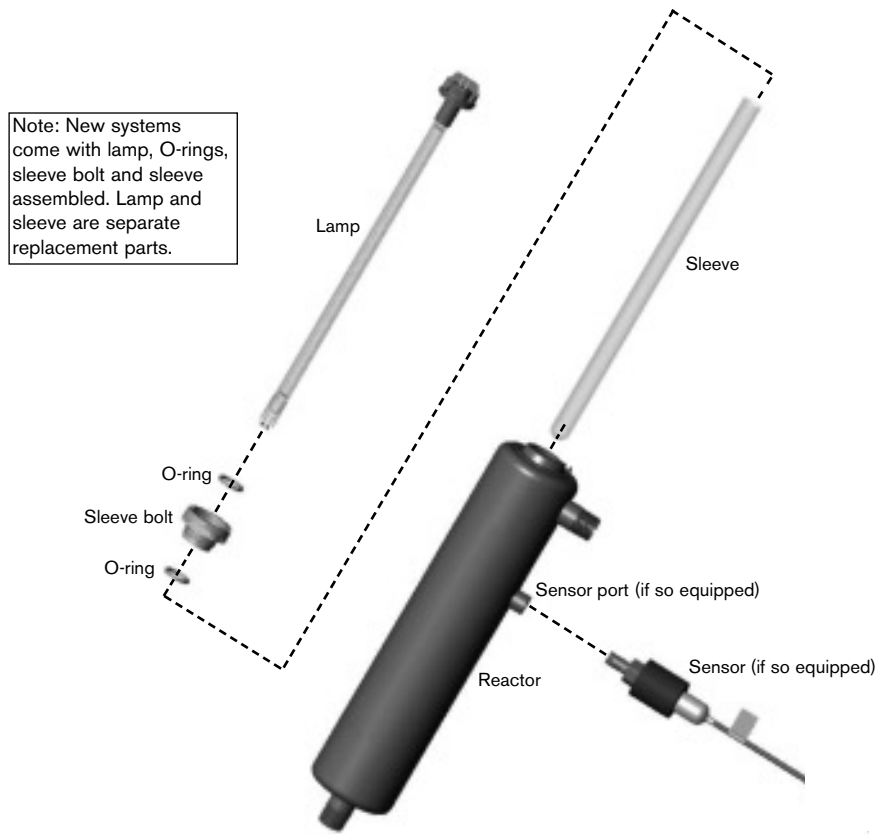

PRODUCT SPECIFICATIONS

MODEL	A	B	C	D	E	F	Pro7	Pro15
Flow Rate	16 dose*	3 (11)	5 (19)	14 (53)	14 (53)	28 (106)	47 (178)	
GPM (LPM)	30 dose*	1 (3.8)	4 (15)	7 (26)	7 (26)	15 (56)	25 (94)	
	40 dose**						8.2 (31)	17.8 (67.4)
Audible/Visual Lamp Failure Alarm	✓	✓	✓	✓	✓	✓	✓	✓
No-tools Maintenance	✓	✓	✓	✓	✓	✓	✓	✓
Safety Cap	✓	✓	✓	✓	✓	✓	✓	✓
Electronic Power Supply	✓	✓	✓	✓	✓	✓	✓	✓
Alarm Postpone	-	-	-	✓	✓	✓	✓	✓
Elapsed Time Meter	-	-	-	✓	✓	✓	✓	✓
Lamp-age Display & Alert	-	-	-	✓	✓	✓	✓	✓
Digital Diagnostic Display	-	-	-	✓	✓	✓	✓	✓
Electropolished Exterior	-	-	-	✓	✓	✓	✓	✓
External Control Relay	-	-	-	✓	✓	✓	✓	✓
UV Intensity Sensor	-	-	-	Optional	Optional	Optional	✓	✓
Solenoid (shut-off valve)***	-	-	-	Optional	Optional	Optional	Optional	Optional
Dynamic Flow Restrictor	-	-	-	Optional	Optional	Optional	✓	✓
Water Chamber Material	304 SST	304 SST	304 SST	304 SST	316 SST	316 SST	316 SST	316 SST
Inlet/Outlet	3/8" FNPT	3/4" NPT or BSP	3/4" NPT or BSP	3/4" NPT or BSP	1" NPT or BSP	1" NPT or BSP	1" NPT	1" NPT

* See sizing charts for details. Flow rates shown are at 85% UVT.

** NSF Standard 55 Class A certifies flow rates shown. The temperature of the flowing water being treated must be between 1°C and 35°C (33.8°F to 95°F).

*** Requires solenoid junction box.

PART NUMBERS

Model	Power Supply*		Lamp		O-Ring	Quartz Sleeve	Sleeve Bolt
	120V	230V	254nm	185nm			
A	650414	650415	602803	602826	002045	602730	602665
B	650411	650412	602804	602827	002045	602731	602665
C	650408	650409	602805	602828	002045	602732	602665

Model	Power Supply*		Lamp Cord**	Power Cord	Lamp		O-Ring	Quartz Sleeve	Sleeve Bolt	UV Sensor			
	120V	230V			254nm	185nm							
D	650405	650421	650406	650422	602799	602636	602637	602805	602828	002045	602732	602665	650505
E	650402	650418	650403	650419	602799	602636	602637	602806	602829	002045	602733	602665	650505
F	650398	650401	650399	650416	602799	602636	602637	602807	602830	002045	602734	602665	650505
Pro7	650510	N/A	650511	N/A	602799	602636	602637	602806	N/A	002045	602733	602665	650505
Pro15	650512	N/A	650513	N/A	602799	602636	602637	602807	N/A	002045	602734	602665	650505

* Includes power and lamp cords

** Without sensor: 602799-120; with sensor: 602799-120S

WATER QUALITY PARAMETERS

These are recommended levels, for use as a guideline for pre-treatment requirements.

Iron: < .3 PPM (.3 mg/L)
Hardness: < 120 PPM (7 Grains Per Gallon)
% UVT: > 75%

ADDITIONAL WATER TREATMENT EQUIPMENT

To meet the water quality parameters described above, you may need to pre-treat your water to ensure appropriate disinfection. Pre-treatment equipment must be installed BEFORE the UV reactor. Ask your water treatment dealer for further information about water quality and testing.

Pre-treatment systems can be comprised of one or more of the following elements:

- Carbon Filter
- Iron Removal System
- Water Softener
- Cyst reduction filter (ANSI/NSF Standard 53 listed)

Required: Pre-treatment MUST INCLUDE a sediment filter (5 micron nominal) installed upstream of (before) the UV system in order to ensure that particles capable of shielding pathogens are removed from the water prior to entering the UV system.

Recommended: Shut off valves should be installed before and after the UV unit, and a sample valve (outlet) should be installed after the unit to allow for pressure-release and water sampling.

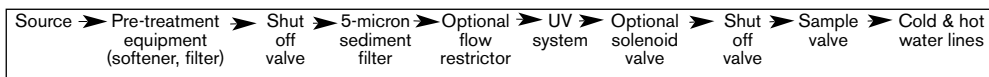

INSTALLATION

Follow the instructions below in order to avoid the risk of voiding your warranty.

1. To protect your power supply, you must use a UL1449 certified transient voltage surge suppressor and a Ground Fault Circuit Interrupter (GFCI).
2. Determine location and orientation of reactor referring to diagrams on pages 10 and 11.
3. Attach reactor clamp(s) to the wall.
4. Insert reactor and tighten clamp(s).
5. Connect to plumbing.
6. Mount power supply to wall, referring to diagrams on pages 10 and 11. Power supply should be installed above all plumbing if possible.
7. Insert power cord into male receptacle on left side of power supply (only on models D, E, F, Pro7 and Pro15).
8. Insert lamp/sleeve assembly (see Figure 9, page 16).
9. Attach the ground (green/yellow) and strain relief (red) wires from the lamp cord to the peg located on the reaction chamber, next to the lamp port (outlet end). Secure both wires with locknut provided.

REACTOR CHAMBER ORIENTATION

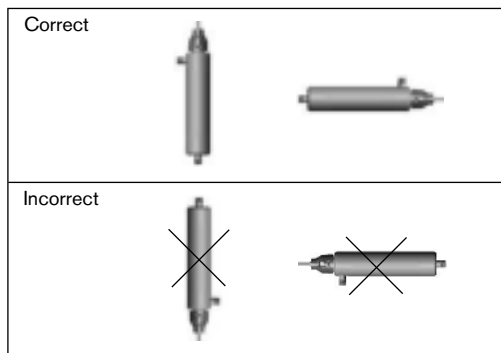

Note: Systems equipped with a sensor are not to be installed horizontally.

MODEL A

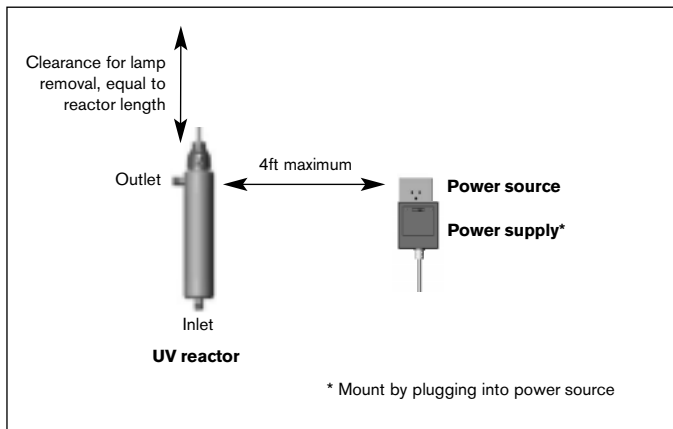

MODELS B & C

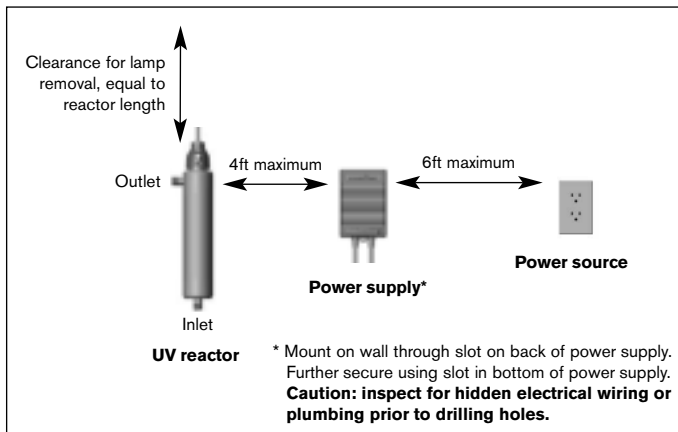

MODELS D, E, F, Pro7 and Pro15

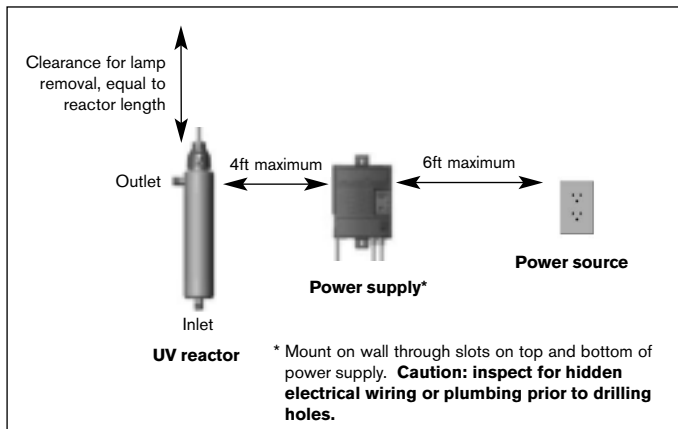

10. Attach lamp cord to lamp (see Figures 10 and 11, page 17).

11. Plug system into the outlet.

Note: When the UV system is first plugged in, the alarm may sound temporarily until the lamp is operational.

12. Clean the distribution lines:

Once the UV system is installed, any contamination in the distribution lines between the UV system and your water outlets must be removed. Similarly, if the power goes out and your system is not equipped with an automatic shut-off feature, you must also disinfect the downstream distribution lines.

- Make sure the UV system is on. Leave the system on during the entire cleaning process.
- Remove a filter housing and fill the filter container with bleach (remove the filter for this process).
- Replace the filter housing and allow water to flow to all faucets (hot and cold, inside and outside the house), your washing machine, toilets, and all other water outlets. Once you can smell bleach in the hot and the cold water, turn the water to that outlet off. When this has been done for all outlets, let the water sit in the water lines for two to four hours.
- Completely flush all the lines a minimum of five minutes and then put the filter back in the filter housing.

OPERATION

Models A, B, and C

Power Supply

Model A is either 90-130V or 180-264V (50-60Hz). Models B & C are either 90-140V (60 Hz) or 190-265V (50Hz).

Indicator Light

When the lamp is operating properly, the indicator light on the power supply will be green. If the lamp is not operating properly, the indicator light will show red (Model A) or will not light (Model B or C) and an audible alarm will sound.

The audible and visual alarm indicators will persist until either the problem is corrected or the system is unplugged from the electrical outlet. Note: If the system is unplugged the water will not be disinfected and the distribution lines will have to be cleaned.

If you experience any kind of alarm (audible or visual), see the Troubleshooting Section of this manual.

Models D, E, F, Pro7, and Pro15

Power Supply

Auto ranging, constant current power supply. Accepts 90-265V at 50-60Hz.

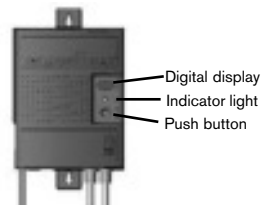

Digital Display

Under normal operating conditions the Digital Display shows the number of months that the lamp has been operating. In the event of a failure of any kind, the display will indicate the nature of the problem. See the Troubleshooting Section for details.

Indicator Light

During normal operation the indicator light will be green.

Indicator light will turn amber:

- when lamp has operated for 11 months
- if UV sensor (if so equipped) detects a low UV output

Indicator light will turn red:

- when lamp has operated for 12 months
- if signal from UV sensor (if so equipped) is below set point
- if there is a failure of any kind, such as a lamp malfunction

An audible alarm will sound whenever the indicator light is red.

The audible and visual alarm indicators will persist until the problem is corrected or the system is unplugged from the electrical outlet. It is possible to disable the audible alarm; see 24-Hour Alarm Postpone Function. Note: If the system is unplugged the water will not be disinfected and the distribution lines will have to be cleaned.

If you experience any kind of alarm (audible or visual), see the Troubleshooting Section of this manual.

Elapsed Time Meter

The Elapsed Time Meter measures the number of months that the lamp has been operating. The lamp must be replaced after it has been operating for 12 months.

- After 11 months indicator light turns amber.
- After 12 months indicator light turns red and alarm sounds.

- After 14 months the alarm postpone function is disabled, indicating that the lamp must be replaced and that it is not providing proper disinfection.
- After lamp replacement, the time meter must be reset (see Elapsed Time Meter Re-Set Function).

Push Button

The push button has two functions.

24-Hour Alarm Postpone Function:

When the unit is in alarm, the indicator light is red and an alarm sounds. If you press the push button for less than two seconds, the indicator light will flash red and the audible alarm will stop. The unit is still in alarm, but the audio alarm stops for your convenience until you can contact a dealer.

This alarm will re-occur after 24 hours if its cause has not been corrected.

If the unit detects another problem during the 24-hour alarm postpone period, it will go into alarm again, the indicator light will turn solid red, and the alarm will sound.

After 14 months of lamp operation, the alarm postpone will not work until the lamp is replaced and the time meter is reset.

Elapsed Time Meter Re-Set Function:

After the lamp has been changed, the Elapsed Time Meter must be reset by following the procedure below:

- a) Disconnect the power supply and leave it unplugged for 10 seconds.
- b) Press and HOLD the push button.
- c) Connect the power supply to the outlet while continuing to press the push button. The indicator light will flash green for about 3 seconds.
- d) Continue to hold the push button until the indicator light flashes red, then release immediately.

External Control Relay

This feature provides switching for the operation of a solenoid (shut-off) valve and/or remote alarm. When the lamp is not operating properly or the UV sensor signals that the UV output is below set point, the contacts will open causing the solenoid to stop the water flow and/or a remote alarm to sound. The dry contact remains open if the lamp has been in operation for 12 months or more.

UV Sensor

The UV sensor measures the amount of UV light reaching it, allowing the system to monitor whether the intensity is above the minimum required for proper disinfection. The sensor is factory calibrated and is not field adjustable.



CAUTION:
UV-C rays are present when the unit is operating. Follow the instructions carefully to avoid injury to eyes and skin. Only qualified persons should install or replace UV lamps or sleeves.

SERVICE AND MAINTENANCE

There are two regular maintenance requirements common to all UV systems: cleaning and lamp replacement.

CLEANING

Minerals in the water will eventually coat the quartz sleeve (which protects the lamp), as well as the sensor (if system is so equipped). This coating must be cleaned off periodically because it reduces the amount of UV light reaching the water, thereby reducing disinfection performance.

Once a month, check the sleeve and clean it if you can see a mineral coating starting to form. If sleeve requires cleaning, refer to Lamp Replacement instructions but re-install the original lamp. If system is equipped with a sensor, be sure to clean the sensor each time the lamp is cleaned, as per Lamp Replacement instructions.

LAMP REPLACEMENT

The lamp's UV intensity decreases over time. You can safely use your lamp for 12 months, after which it must be replaced. For instance, if you use your system for 12 continuous months, you must replace your lamp at the end of this period. If you use the system only six months each year, you would need

to change your lamp at the end of the second six-month period.

Follow the steps outlined below to replace your lamp.

Lamp Removal

1. Shut off water supply to (upstream of) the UV system.
2. Open a tap downstream of the UV unit to release pressure, then close this tap.
3. Unplug the power supply and let the lamp cool for 5 minutes.
4. Squeeze the sides of the safety cap in the area opposite the tabs (do not squeeze tabs), and remove the cap (Figure 1).
5. Pull the lamp plug off the lamp end (Figure 2). Do not pull on the cord when removing the plug. Note: During lamp replacement, the ground and strain relief wires of the lamp plug should remain connected to the peg on the reactor.
6. Holding the sleeve bolt, unscrew the lamp/sleeve assembly and carefully remove it from the reactor (Figure 3). Handle assembly by ends only. If required, a wrench can be placed on the two flat sides of the sleeve bolt. Do NOT apply the wrench to the lamp end, which sits within the sleeve bolt and protrudes 1/2".

- To remove the lamp from its sleeve, use a glove or cloth to support and hold on to the sleeve. Holding the sleeve bolt tight, unscrew the lamp end, the top of which protrudes 1/2" above the sleeve bolt (Figure 4). Be careful not to drop the sleeve.

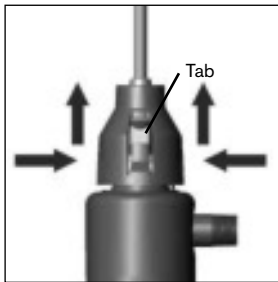

Figure 1

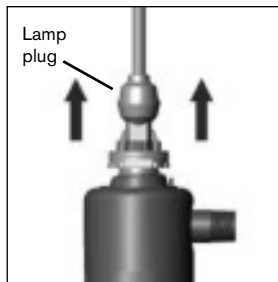

Figure 2

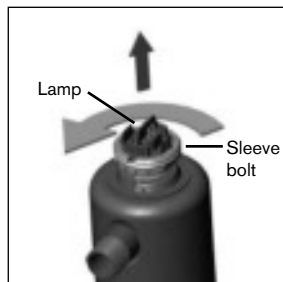

Figure 3

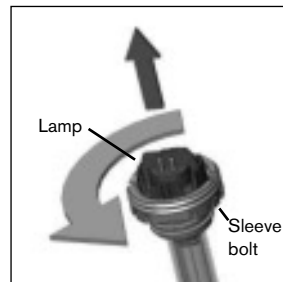

Figure 4

Cleaning

- Remove first O-ring, sleeve bolt and second O-ring from lamp sleeve (Figure 5).
- Clean lamp sleeve and sleeve bolt using a soft, lint-free cotton cloth (NOT paper towel or toilet paper) and a chemical scale-remover

such as Lime-a-Way™ or CLR™ (follow manufacturer's directions). Remove all traces of cleaning solution by thoroughly rinsing.

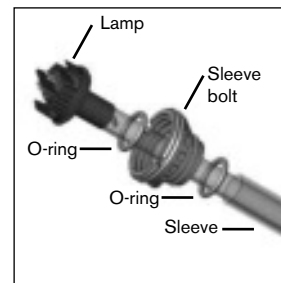

Figure 5

If unit is not equipped with a UV sensor, skip to "Lamp Installation".

- Unscrew the sensor from the sensor port in the side of the reactor (Figure 6).
- Inspect the two O-rings on the UV sensor for signs of damage or wear.
- Ensure that the O-rings and any surfaces in contact with them are clean.
- Clean the quartz-glass window of the UV sensor using a soft, lint-free cotton swab and a chemical scale-remover such as Lime-a-Way™ or CLR™ (follow manufacturer's

directions). Remove all traces of cleaning solution by thoroughly rinsing.

7. Insert the UV sensor completely into the sensor port, turning the sensor slowly while doing so. Water may be put on the sensor O-ring to facilitate this procedure.
8. Screw the brass nut on finger tight. **Caution: Over tightening may cause leakage.**

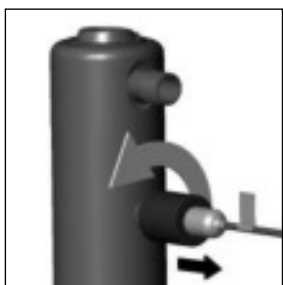

Figure 6

Lamp Installation

1. Each lamp and sleeve comes with two new O-rings. Place the new O-rings and the original sleeve bolt on the lamp sleeve as per Figure 7. **Caution: Do not lubricate any of the O-rings.**
2. Put the lamp completely into the sleeve. Maintain it in that position

and screw the sleeve bolt into the lamp end until solidly hand-tight (Figure 8). **Caution: Over tightening will break the quartz lamp sleeve.**

3. Carefully place the lamp/ sleeve assembly into the reactor, making sure it is centered. Apply pressure to the assembly and screw it into the reactor until solidly hand-tight (Figure 9). **Caution: Over tightening will break the quartz lamp sleeve.**

4. Push the plug onto the end of the lamp while ensuring that the male tab on the lamp inserts into the female tab on the plug (Figure 10).
5. Push the safety cap on while ensuring that the grounding wires are under the cap and not in the way of the tabs (Figure 11).

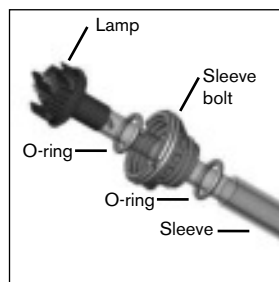

Figure 7

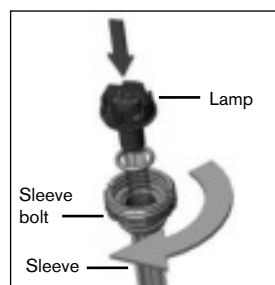

Figure 8

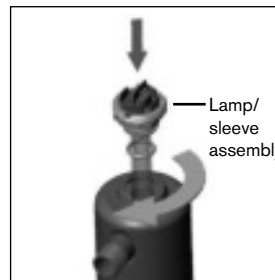

Figure 9

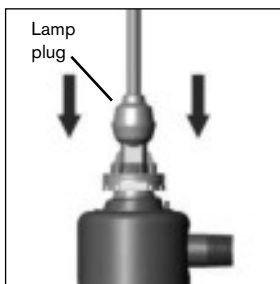

Figure 10

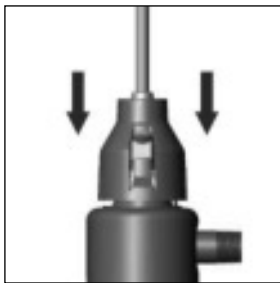

Figure 11

Restarting

For models A, B and C:

1. Connect the power supply to the outlet.

For all other models:

1. Press and hold the push button (Figure 12).

2. Connect the power supply to the outlet while continuing to press the push button. The indicator light will flash green for about 3 seconds.
3. Continue to hold the push button until the indicator light flashes red, then release immediately.
4. Open the water line and check for leaks.

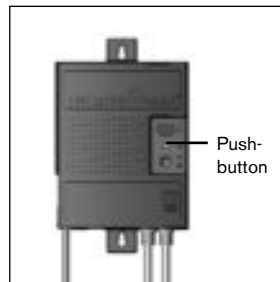

Figure 12

Disinfecting the Lines

It is recommended that the distribution lines be cleaned following any maintenance procedure in which the water in the lines may have been exposed to the air or to any undisinfected water.

1. Remove a filter housing, remove the filter, and fill the housing container with bleach. Replace the filter housing.
2. Allow water to flow to all faucets (hot and cold, inside and outside of the house), your washing machine, toilets, and all other outlets. Once you can smell bleach in the hot and the cold water, turn the water to that outlet off. When this has been done for all outlets, let the water sit in the water lines for two to four hours.
3. Completely flush all the lines a minimum of five minutes and then put the filter back in the filter housing.

WARRANTY

Our Commitment

To maximize the superior quality of Trojan UV disinfection, each product must be properly sized, installed, and maintained. If you experience difficulty with your Trojan product, our Technical Support Centre is available to help you.

During the applicable warranty period noted below, Trojan will provide warranty coverage, described below, for your product. After the product's warranty expires, repairs and replacement parts can be provided to you for a reasonable charge.

How to Get Help

To obtain help under this warranty, contact the Trojan Technical Support Center at 1-800-265-5774 or by email at residential@trojanuv.com. Please have available the model number, the date of purchase, the name of the dealer from whom you purchased your Trojan product ("the source dealer"), as well as a description of the problem you are experiencing. A Trojan technician will help you troubleshoot the problem and isolate the defective part.

For more information, please refer to the Troubleshooting section of your Owner's Manual. Owner's Manual information is also available at www.trojanuv.com

To establish proof of purchase to make a warranty claim, you will need to either retain your original invoice or complete and return a warranty card, which will register you as a product owner in Trojan's database.

Specific Warranty Coverage

Warranty coverage is specific to the following Trojan products:

- TrojanUVMax™
- Advantage Series
- UV 700 Series
- UV 600 Series

Ten-Year Limited Warranty for TrojanUVMax™ Reaction Chamber

Trojan warrants the reaction chamber on the TrojanUVMax™ product to be free from defects in material and workmanship for a period of ten (10) years from the date of purchase. During this time, Trojan will repair or replace, at its option, any defective TrojanUVMax™ reaction chamber.

Please return the defective part to a Trojan dealer, who will return it to Trojan. Trojan will either make the necessary repairs or, if Trojan determines that a replacement is required, will provide a replacement part. Trojan will then return the part to the dealer. This warranty does not include shipping and handling charges which will be collected from you by the dealer.

Parts repaired or replaced under this ten (10) year warranty will be covered under warranty to the end of the original ten (10) year warranty period.

This warranty is also subject to the conditions and limitations outlined under the heading "General Conditions and Limitations" below.

Five-Year Limited Warranty for Structural, Hardware and Electrical Components

Trojan warrants the structural, hardware, and electrical components to be free from defects in material and workmanship for a period of five (5) years from the date of purchase. During this time, Trojan will repair or replace, at its option, any defective parts covered by the warranty.

Please return the defective part to a Trojan dealer, who will return it to Trojan. Trojan will either make the necessary repairs or, if Trojan determines that a replacement is required, will provide a replacement part. Trojan will then return the part to the dealer. This warranty does not include shipping and handling charges which will be collected from you by the dealer.

Parts repaired or replaced under this five (5) year warranty will be covered under warranty to the end of the original five (5) year warranty period.

This warranty is also subject to the conditions and limitations outlined under the heading "General Conditions and Limitations" below.

One-Year Limited Warranty for Lamps, Sleeves and UV Sensors

Trojan warrants lamps, sleeves and UV sensors to be free from defects in material and workmanship for a period of one (1) year from the date of purchase. During this time, Trojan will repair or

replace, at its option, any defective parts covered by the warranty.

The warranty period for lamps and sleeves may be verified using date codes in addition to purchase receipts and Trojan's database of registered owners. Trojan will advise you whether the defective item needs to be returned to a Trojan dealer for failure analysis. Replacement lamps and sleeves provided under warranty will be sent to your Trojan dealer.

If the UV sensor experiences a problem which Trojan confirms is covered by warranty, please return the sensor to a Trojan dealer who will return it to Trojan. Trojan will either repair or replace the sensor and return the sensor to your dealer.

This warranty on lamps, sleeves and sensors does not include shipping and handling charges which will be collected from you by the dealer.

Parts replaced under this one (1) year warranty will be covered under warranty to the end of the original one (1) year warranty period.

This warranty is also subject to the conditions and limitations outlined under the heading "General Conditions and Limitations" below.

Warranty for Replacement Lamps and Parts

Trojan warrants replacement lamps, purchased for annual routine maintenance, and other parts purchased to repair product components that are

no longer covered by the original warranty, to be free from defects in material and workmanship for a period of three (3) months from the date of purchase. During this time, Trojan will repair or replace, at its option, a defective replacement lamp or part free of charge except for shipping and handling charges.

The warranty period on replacement lamps and parts will be verified using date codes and/or purchase receipts. Trojan will advise you whether the defective item needs to be returned to a Trojan dealer for failure analysis. Replacement lamps and parts provided under warranty will be sent to your Trojan dealer.

General Conditions and Limitations

None of the above warranties cover damage caused by improper use or maintenance, accidents, acts of God or minor scratches or imperfections that do not materially impair the operation of the product. The warranties also do not cover products that are not installed as outlined in the applicable Owner's Manual.

The limited warranties described above are the only warranties applicable to the Trojan products listed in the "Specific Warranty Coverage" section. These limited warranties outline the exclusive remedy for all claims based on a failure of or defect in any of these products, whether the claim is based on contract, tort (including negligence), strict liability or otherwise. These warranties are in

lieu of all other warranties whether written, oral, implied or statutory. Without limitation, no warranty of merchantability or of fitness for a particular purpose shall apply to any of these products.

Trojan does not assume any liability for personal injury or property damage caused by the use or misuse of any of the above products. Trojan shall not in any event be liable for special, incidental, indirect or consequential damages. Trojan's liability shall, in all instances, be limited to repair or replacement of the defective product or part and this liability will terminate upon expiration of the applicable warranty period.

Troubleshooting

Models A, B, C

SITUATION	POSSIBLE CAUSE	POSSIBLE SOLUTION
Breaker repeatedly trips	Connection between lamp and lamp cord is wet Short circuit in the electrical assembly	Clean and dry the cord and lamp, check unit for leaks Replace power supply
Leak at inlet or outlet	Threaded pipe fittings are leaking	Clean threads, reseal with Teflon tape, and re-tighten
Leak detected from area of reactor	Condensation of moist air on cold reactor (slow accumulation) O-ring on sleeve bolt damaged, deteriorated, or incorrectly installed Lamp/sleeve assembly not properly installed (too tight or not tight enough)	Control humidity, relocate unit, or insulate reactor Inspect and replace if deteriorated Tighten assembly solidly hand-tight
Audible alarm	Power failure, lamp failure	Unplug for 2 minutes then restart Replace lamp Replace power supply

Troubleshooting

Models D, E, F, Pro 7 and Pro 15

SITUATION	POSSIBLE CAUSE	POSSIBLE SOLUTION
Digital display does not read anything	Unit is unplugged No power at AC power outlet Power cord is damaged Power surge caused damage to electrical assembly	Plug unit into AC power outlet Replace fuse or reset breaker Replace power cord Replace power supply and use a surge protector
Breaker repeatedly trips	Connection between lamp and lamp cord is wet Short circuit in the electrical assembly	Clean and dry the cord and lamp, check unit for leaks Replace power supply
Leak at inlet or outlet	Threaded pipe fittings are leaking	Clean threads, reseal with Teflon tape, and re-tighten
Leak detected from area of reactor	Condensation of moist air on cold reactor (slow accumulation) O-ring on sleeve bolt damaged, deteriorated, or incorrectly installed Lamp/sleeve assembly not properly installed (too tight or not tight enough)	Control humidity, relocate unit, or insulate reactor Inspect and replace if deteriorated Tighten assembly solidly hand-tight
Digital Display indicates a number between 0 and 10	Not an alarm condition	
Digital Display indicates 11	Not an alarm condition; lamp is in its 12th month of operation and will require replacement shortly	Ensure that you have a replacement lamp on hand
Digital Display indicates 12, 13 or 14	Lamp has reached the end of its life	Replace lamp and reset elapsed time meter
Digital Display indicates L0, L1, L2, or L3	Lamp is not operating	Inspect lamp cord and reconnect; ensure safety cap snaps into place Replace lamp and reset elapsed time meter
Digital Display reads F0 or F1	Power supply failure	Restart; if this fails, replace power supply
Digital Display reads C0	Indicator light is malfunctioning	Restart; if this fails, replace power supply

Note: If push-button is pressed during an alarm condition, the audible alarm is postponed 24 hours. The alarm condition persists.

Troubleshooting

Systems with Sensors

SITUATION	POSSIBLE CAUSE	POSSIBLE SOLUTION
Digital Display reads A3	Not an alarm condition; system in high temperature mode	The system will do this every time the water is not flowing for more than 3-4 hours or is not in the correct temperature range. This warning will self-correct after water is allowed to flow through the system.
Digital Display reads A0	Quartz-glass sleeve has become coated UV sensor failing to detect the correct amount of UV energy Lamp intensity is below safety level due to lamp age Ultraviolet transmittance (UVT) of the water is below 75%.	Follow cleaning procedures in manual Ensure sensor is clean Ensure lamp/sleeve has been inserted properly; remove and re-insert Replace UV sensor if defective Replace lamp Install prefiltration equipment to improve UVT of inlet water to recommended levels
Digital Display reads EO	Sensorboard failure	Replace sensor
Leak detected at sensor	UV sensor O-rings are damaged, deteriorated, or incorrectly installed	Inspect and replace O-rings if deteriorated



NSF information pertains to TrojanUVMax™ Pro7 and Pro15 models



System tested and certified by NSF International against ANSI/NSF Standard 55 for disinfection performance, Class A.

This Class A system conforms to NSF Standard 55 for the disinfection of microbiologically contaminated water that meets all other public health standards. The system is not intended for treatment of water that has an obvious contamination source, such as raw sewage; nor is the system intended to convert wastewater to microbiologically safe drinking water. The system is intended to be installed on visually clear water (not coloured, cloudy, or turbid water). If this system is used for the treatment of surface waters a prefilter found to be in compliance for cyst reduction under ANSI/NSF Standard 53: Drinking Water Treatment Units - Health Effects shall be installed upstream of the system.

NSF Standard 55 defines waste water to include human and/or animal body waste, toilet paper, and any other material intended to be deposited in a receptacle designed to receive urine and/or feces (black waste); and other waste materials deposited in plumbing fixtures (gray waste).

Installed by: _____

Date of installation: _____

Service numbers:

Installer - call _____

Trojan - call (519) 457-3400

Serial number: _____ (see decal on back of power supply)

Model installed (check):

A

B

C

D

E Pro7

F Pro15

Corresponding lamp:

602803

602804

602805

602806

602807



Lamps **must** be replaced after 12 months of operation to ensure proper disinfection of your water.

Clean quartz sleeve and UV sensor (if equipped) frequently for optimum performance.

Lamp replacement dates:

1st: _____	6th: _____
2nd: _____	7th: _____
3rd: _____	8th: _____
4th: _____	9th: _____
5th: _____	10th: _____

 **Printed in Canada.** Copyright ©2001 Trojan Technologies Inc. London, Ontario, Canada.
No part of this manual may be reproduced, stored in a retrieval system, or transmitted in any form or by any means without the written permission of Trojan Technologies Inc.
602669 Rev D



Head Office 3020 Gore Road, London, Ontario, Canada N5V 4T7
Tel: (519) 457-3400 Fax: (519) 457-3030

www.trojanuv.com